

Network Analyzer Basics

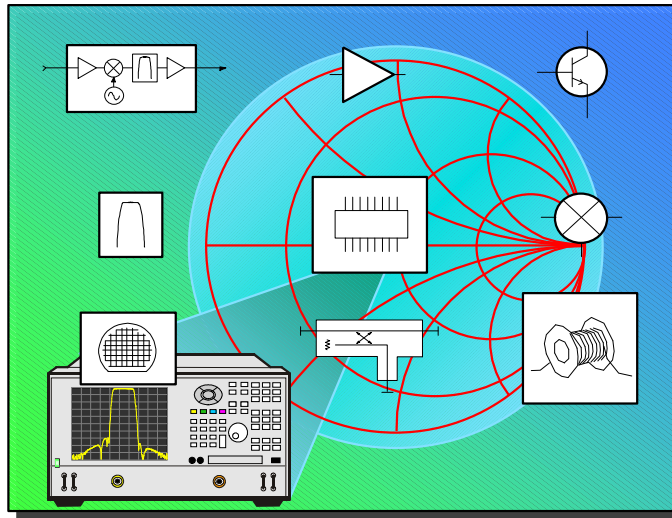

Network Analyzer Basics

 **Agilent Technologies**

www.agilent.com/find/backtobasics

Slide 1

Welcome to Network Analyzer Basics.

This presentation covers the principles of measuring high-frequency electrical networks with network analyzers. Attendees will learn what kind of measurements are made with network analyzers and how they allow characterization of linear and nonlinear device behavior. The session starts with RF fundamentals and takes you through the concepts of reflection, transmission and S-parameters. The presenters will review the major components of a network analyzer as well as the advantages and limitations of different hardware approaches. The presentation will cover accuracy enhancement and various calibration techniques. Finally, we will conclude with network analyzer measurements performed on filters, amplifiers, mixers, and balanced components.

An appendix is also included with information on some advanced topics, with references to more information.

Network Analysis is NOT....

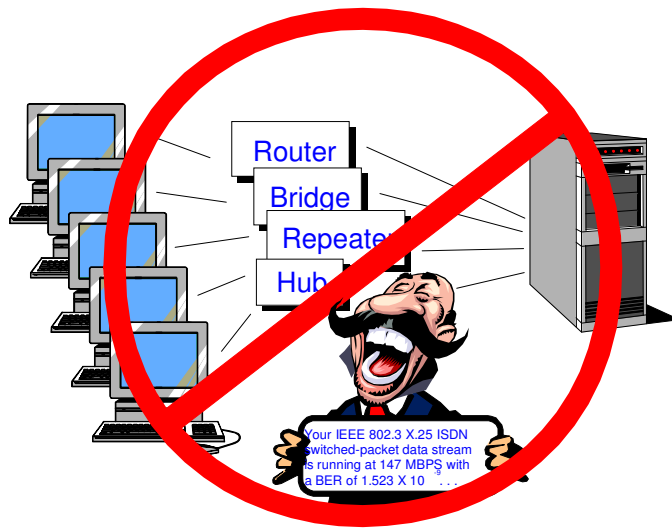

Network Analyzer Basics

 **Agilent Technologies**

www.agilent.com/find/backtobasics

Slide 2

This module is not about computer networks! When the name "network analyzer" was coined many years ago, there were no such things as computer networks. Back then, networks always referred to *electrical* networks. Today, when we refer to the things that network analyzers measure, we speak mostly about devices and components.

What Types of Devices are Tested?

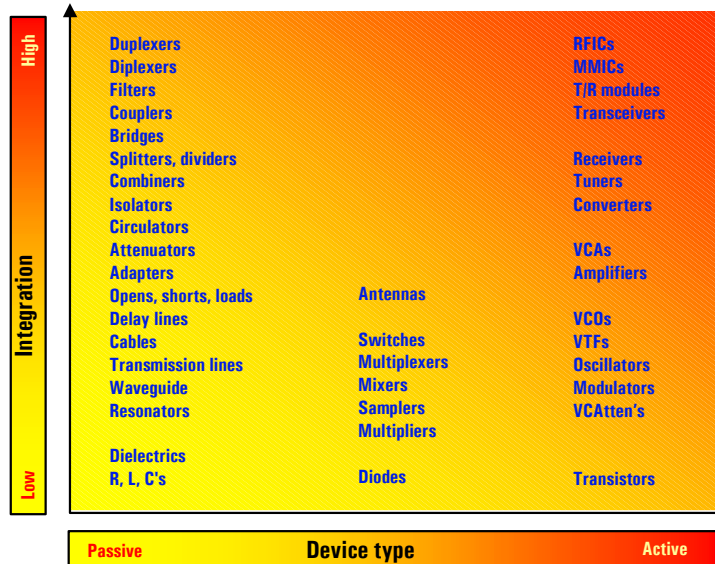

Network Analyzer Basics

 Agilent Technologies

www.agilent.com/find/backtobasics

Slide 3

Here are some examples of the types of devices that you can test with network analyzers. They include both passive and active devices (and some that have attributes of both). Many of these devices need to be characterized for both linear and nonlinear behavior. It is not possible to completely characterize all of these devices with just one piece of test equipment.

The next slide shows a model covering the wide range of measurements necessary for complete linear and nonlinear characterization of devices. This model requires a variety of stimulus and response tools. It takes a large range of test equipment to accomplish all of the measurements shown on this chart. Some instruments are optimized for one test only (like bit-error rate), while others, like network analyzers, are much more general-purpose in nature. Network analyzers can measure both linear and nonlinear behavior of devices, although the measurement techniques are different (frequency versus power sweeps for example). This module focuses on swept-frequency and swept-power measurements made with network analyzers

Device Test Measurement Model

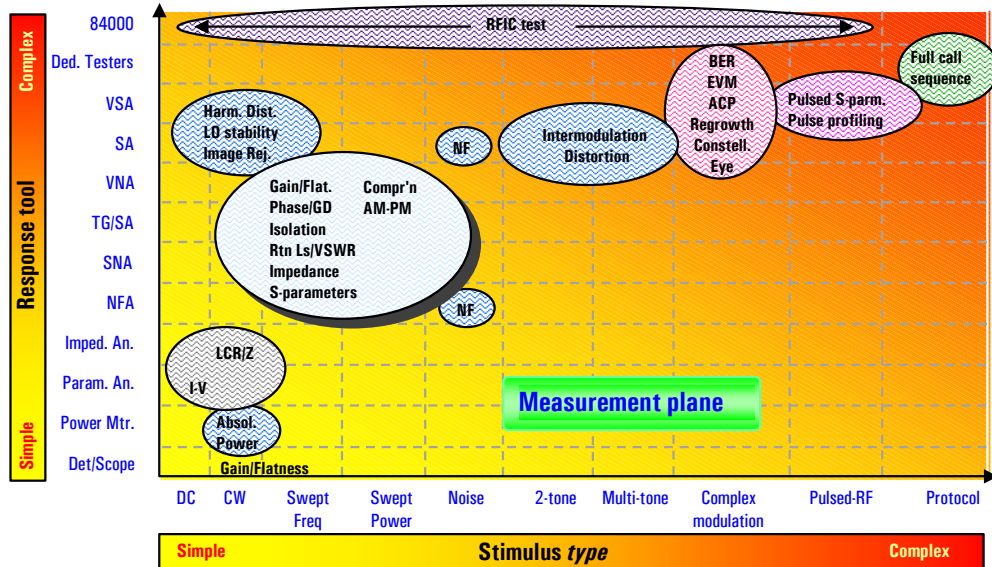

Network Analyzer Basics



Agilent Technologies

www.agilent.com/find/backtobasics

Slide 4

Here is a key to many of the abbreviations used above:

Response

84000	84000 series high-volume RFIC tester
Ded. Testers	Dedicated (usually one-box) testers
VSA	Vector signal analyzer
SA	Spectrum analyzer
VNA	Vector network analyzer
TG/SA	Tracking generator/spectrum analyzer
SNA	Scalar network analyzer
NFA	Noise-figure analyzer
Imped. An.	Impedance analyzer (LCR meter)
Power Mtr.	Power meter
Det./Scope	Diode detector/oscilloscope

Measurement

ACP	Adjacent channel power
AM-PM	AM to PM conversion
BER	Bit-error rate
Compr'n	Gain compression
Constell.	Constellation diagram
EVM	Error-vector magnitude
Eye	Eye diagram
GD	Group delay
Harm. Dist.	Harmonic distortion
NF	Noise figure
Regrowth	Spectral regrowth
Rtn Ls	Return loss
VSWR	Voltage standing wave ratio

Lightwave Analogy to RF Energy

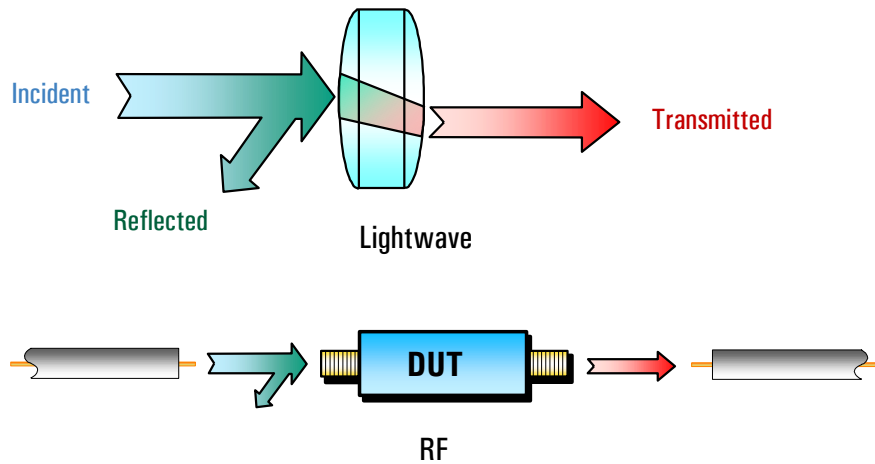

Network Analyzer Basics

 **Agilent Technologies**

www.agilent.com/find/backtobasics

Slide 5

One of the most fundamental concepts of high-frequency network analysis involves incident, reflected and transmitted waves traveling along transmission lines. It is helpful to think of traveling waves along a transmission line in terms of a lightwave analogy. We can imagine incident light striking some optical component like a clear lens. Some of the light is reflected off the surface of the lens, but most of the light continues on through the lens. If the lens were made of some lossy material, then a portion of the light could be absorbed within the lens. If the lens had mirrored surfaces, then most of the light would be reflected and little or none would be transmitted through the lens. This concept is valid for RF signals as well, except the electromagnetic energy is in the RF range instead of the optical range, and our components and circuits are electrical devices and networks instead of lenses and mirrors.

Network analysis is concerned with the accurate measurement of the *ratios* of the reflected signal to the incident signal, and the transmitted signal to the incident signal.

Why Do We Need to Test Components?

- Verify specifications of “building blocks” for more complex RF systems

- Ensure distortionless transmission of communications signals

- linear: constant amplitude, linear phase / constant group delay
- nonlinear: harmonics, intermodulation, compression, AM-to-PM conversion



- Ensure good match when absorbing power (e.g., an antenna)

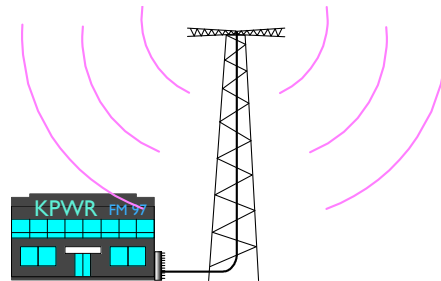

Network Analyzer Basics

 Agilent Technologies

www.agilent.com/find/backtobasics

Slide 6

Components are tested for a variety of reasons. Many components are used as “building blocks” in more complicated RF systems. For example, in most transceivers there are amplifiers to boost LO power to mixers, and filters to remove signal harmonics. Often, R&D engineers need to measure these components to verify their simulation models and their actual hardware prototypes. For component production, a manufacturer must measure the performance of their products so they can provide accurate specifications. This is essential so prospective customers will know how a particular component will behave in their application.

When used in communications systems to pass signals, designers want to ensure the component or circuit is not causing excessive signal distortion. This can be in the form of linear distortion where flat magnitude and linear phase shift versus frequency is not maintained over the bandwidth of interest, or in the form of nonlinear effects like intermodulation distortion.

Often it is most important to measure how reflective a component is, to ensure that it absorbs energy efficiently. Measuring antenna match is a good example.

The Need for Both Magnitude and Phase

1. Complete characterization of linear networks

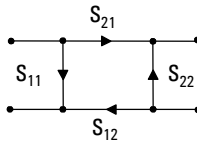

2. Complex impedance needed to design matching circuits

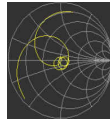

3. Complex values needed for device modeling

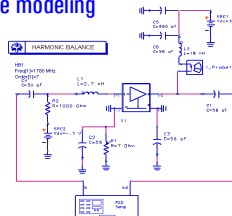

4. Time-domain characterization

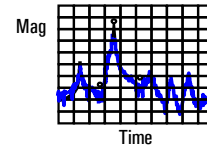

5. Vector-error correction

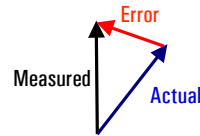

Network Analyzer Basics

 Agilent Technologies

www.agilent.com/find/backtobasics

Slide 7

In many situations, magnitude-only data is sufficient for our needs. For example, we may only care about the gain of an amplifier or the stop-band rejection of a filter. However, as we will explore throughout this paper, measuring phase is a critical element of network analysis.

Complete characterization of devices and networks involves measurement of phase as well as magnitude. This is necessary for developing circuit models for simulation and to design matching circuits based on conjugate-matching techniques. Time-domain characterization requires magnitude and phase information to perform the inverse-Fourier transform. Finally, for best measurement accuracy, phase data is required to perform vector error correction.

Agenda

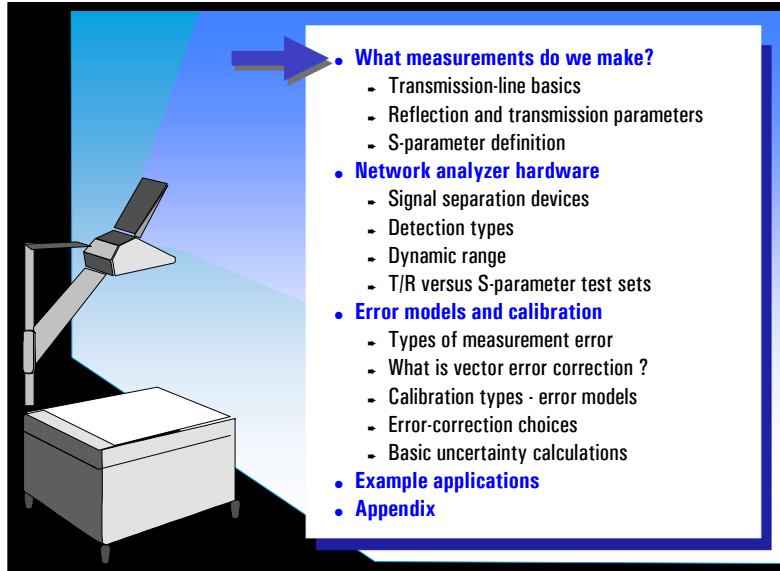

- **What measurements do we make?**
 - Transmission-line basics
 - Reflection and transmission parameters
 - S-parameter definition
- **Network analyzer hardware**
 - Signal separation devices
 - Detection types
 - Dynamic range
 - T/R versus S-parameter test sets
- **Error models and calibration**
 - Types of measurement error
 - What is vector error correction ?
 - Calibration types - error models
 - Error-correction choices
 - Basic uncertainty calculations
- **Example applications**
- **Appendix**

Network Analyzer Basics



Agilent Technologies

www.agilent.com/find/backtobasics

Slide 8

In this section we will review reflection and transmission measurements. We will see that transmission lines are needed to convey RF and microwave energy from one point to another with minimal loss, that transmission lines have a characteristic impedance, and that a termination at the end of a transmission line must match the characteristic impedance of the line to prevent loss of energy due to reflections. We will see how the Smith chart simplifies the process of converting reflection data to the complex impedance of the termination. For transmission measurements, we will discuss not only simple gain and loss but distortion introduced by linear devices. We will introduce S-parameters and explain why they are used instead of h-, y-, or z-parameters at RF and microwave frequencies.

Transmission Line Basics

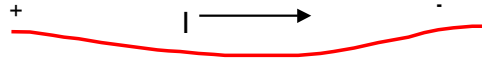

Low frequencies

- wavelengths \gg wire length
- current (I) travels down wires easily for efficient power transmission
- measured voltage and current not dependent on position along wire

Freq.	Wavelength
60 Hz	5000 km
10 MHz	30 m
1 GHz	30 cm
40 GHz	7.5 mm
100 GHz	3 mm



High frequencies

- wavelength \approx or \ll length of transmission medium
- need transmission lines for efficient power transmission
- matching to characteristic impedance (Z_0) is very important for low reflection and maximum power transfer
- measured envelope voltage dependent on position along line

Network Analyzer Basics



Agilent Technologies

www.agilent.com/find/backtobasics

Slide 9

The need for efficient transfer of RF power is one of the main reasons behind the use of transmission lines. At low frequencies where the wavelength of the signals are much larger than the length of the circuit conductors, a simple wire is very useful for carrying power. Current travels down the wire easily, and voltage and current are the same no matter where we measure along the wire.

At high frequencies however, the wavelength of signals of interest are comparable to or much smaller than the length of conductors. In this case, power transmission can best be thought of in terms of traveling waves.

Of critical importance is that a lossless transmission line takes on a characteristic impedance (Z_0). In fact, an infinitely long transmission line appears to be a resistive load! When the transmission line is terminated in its characteristic impedance, maximum power is transferred to the load. When the termination is not Z_0 , the portion of the signal which is not absorbed by the load is reflected back toward the source. This creates a condition where the envelope voltage along the transmission line varies with position. We will examine the incident and reflected waves on transmission lines with different load conditions in following slides

Transmission line Z_0

- Z_0 determines relationship between voltage and current waves
- Z_0 is a function of physical dimensions and ϵ_r
- Z_0 is usually a real impedance (e.g. 50 or 75 ohms)

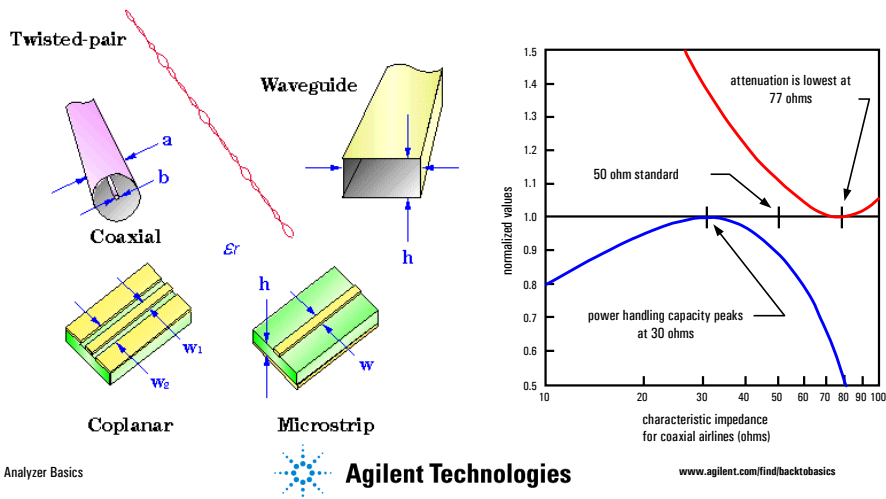

Slide 10

RF transmission lines can be made in a variety of transmission media. Common examples are coaxial, waveguide, twisted pair, coplanar, stripline and microstrip. RF circuit design on printed-circuit boards (PCB) often use coplanar or microstrip transmission lines. The fundamental parameter of a transmission line is its characteristic impedance Z_0 . Z_0 describes the relationship between the voltage and current traveling waves, and is a function of the various dimensions of the transmission line and the dielectric constant (ϵ_r) of the non-conducting material in the transmission line. For most RF systems, Z_0 is either 50 or 75 ohms.

For low-power situations (cable TV, for example) coaxial transmission lines are optimized for low loss, which works out to about 75 ohms (for coaxial transmission lines with air dielectric). For RF and microwave communication and radar applications, where high power is often encountered, coaxial transmission lines are designed to have a characteristic impedance of 50 ohms, a compromise between maximum power handling (occurring at 30 ohms) and minimum loss.

Power Transfer Efficiency

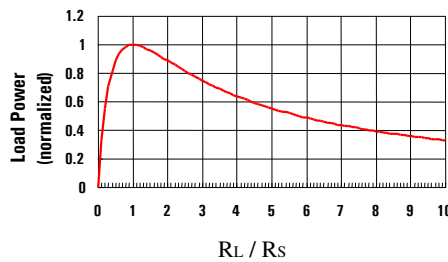
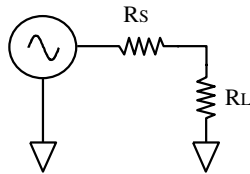

Maximum power is transferred when $R_L = R_S$

For complex impedances, maximum power transfer occurs when $Z_L = Z_S^*$ (conjugate match)

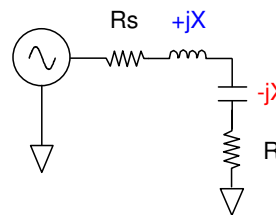

Network Analyzer Basics

 Agilent Technologies

www.agilent.com/find/backtobasics

Slide 11

Before we begin our discussion about transmission lines, let us look at the condition for maximum power transfer into a load, given a source impedance of R_s . The graph above shows that the matched condition ($R_L = R_S$) results in the maximum power dissipated in the load resistor. This condition is true whether the stimulus is a DC voltage source or an RF sinusoid.

For maximum transfer of energy into a transmission line from a source or from a transmission line to a load (the next stage of an amplifier, an antenna, etc.), the impedance of the source and load should match the characteristic impedance of the transmission line. In general, then, Z_0 is the target for input and output impedances of devices and networks.

When the source impedance is not purely resistive, the maximum power transfer occurs when the load impedance is equal to the complex conjugate of the source impedance. This condition is met by reversing the sign of the imaginary part of the impedance. For example, if $R_S = 0.6 + j0.3$, then the complex conjugate $R_S^* = 0.6 - j0.3$.

Sometimes the source impedance is adjusted to be the complex conjugate of the load impedance. For example, when matching to an antenna, the load impedance is determined by the characteristics of the antenna. A designer has to optimize the output match of the RF amplifier over the frequency range of the antenna so that maximum RF power is transmitted through the antenna

Transmission Line Terminated with Z_0

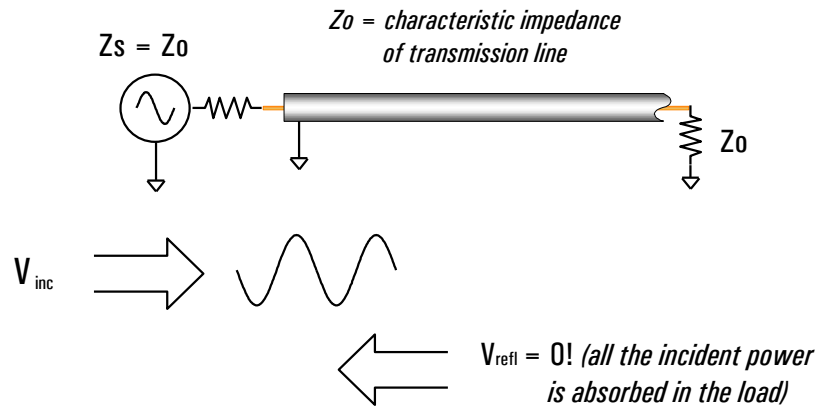

For reflection, a transmission line terminated in Z_0 behaves like an infinitely long transmission line

Network Analyzer Basics

 **Agilent Technologies**

www.agilent.com/find/backtobasics

Slide 12

Let's review what happens when transmission lines are terminated in various impedances, starting with a Z_0 load. Since a transmission line terminated in its characteristic impedance results in maximum transfer of power to the load, there is no reflected signal. This result is the same as if the transmission line was infinitely long. If we were to look at the envelope of the RF signal versus distance along the transmission line, it would be constant (no standing-wave pattern). This is because there is energy flowing in one direction only.

Transmission Line Terminated with Short, Open

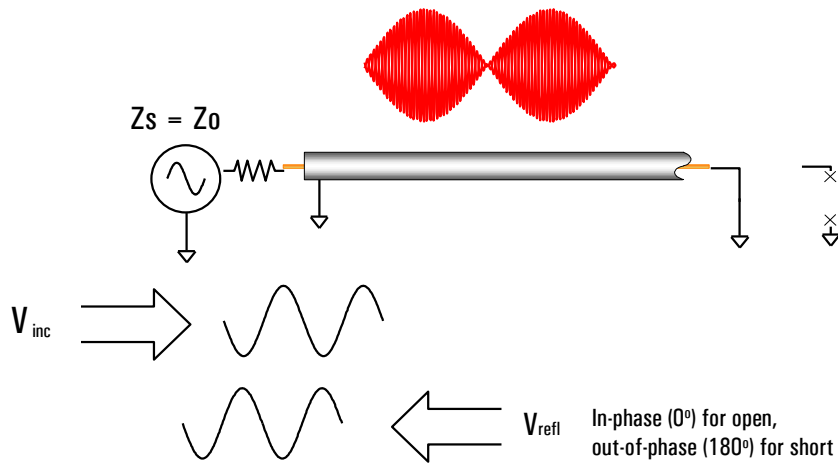

For reflection, a transmission line terminated in a short or open reflects all power back to source

Network Analyzer Basics

 **Agilent Technologies**

www.agilent.com/find/backtobasics

Slide 13

Next, let's terminate our line in a short circuit. Since purely reactive elements cannot dissipate any power, and there is nowhere else for the energy to go, a reflected wave is launched back down the line toward the source. For Ohm's law to be satisfied (no voltage across the short), this reflected wave must be equal in voltage magnitude to the incident wave, and be 180° out of phase with it. This satisfies the condition that the total voltage must equal zero at the plane of the short circuit. Our reflected and incident voltage (and current) waves will be identical in magnitude but traveling in the opposite direction.

Now let us leave our line open. This time, Ohm's law tells us that the open can support no current. Therefore, our reflected current wave must be 180° out of phase with respect to the incident wave (the voltage wave will be in phase with the incident wave). This guarantees that current at the open will be zero. Again, our reflected and incident current (and voltage) waves will be identical in magnitude, but traveling in the opposite direction. For both the short and open cases, a standing-wave pattern will be set up on the transmission line. The valleys will be at zero and the peaks at twice the incident voltage level. The peaks and valleys of the short and open will be shifted in position along the line with respect to each other, in order to satisfy Ohm's law as described above.

Transmission Line Terminated with $25\ \Omega$

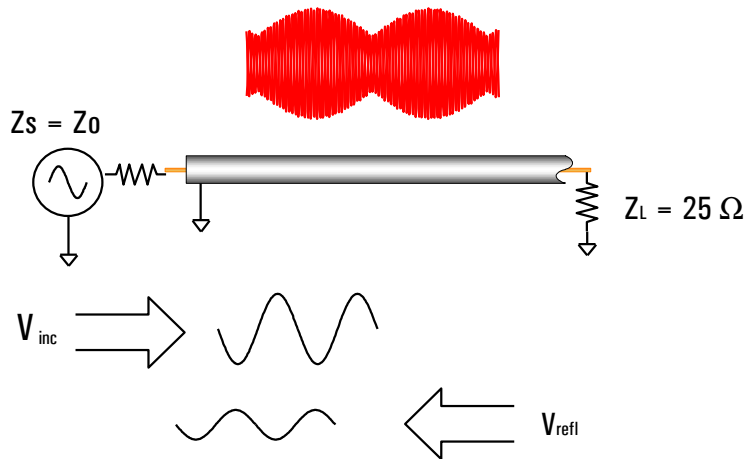

Standing wave pattern does not go to zero as with short or open

Network Analyzer Basics

 **Agilent Technologies**

www.agilent.com/find/backtobasics

Slide 14

Finally, let's terminate our line with a $25\ \Omega$ resistor (an impedance between the full reflection of an open or short circuit and the perfect termination of a $50\ \Omega$ load). Some (but not all) of our incident energy will be absorbed in the load, and some will be reflected back towards the source. We will find that our reflected voltage wave will have an amplitude $1/3$ that of the incident wave, and that the two waves will be 180° out of phase at the load. The phase relationship between the incident and reflected waves will change as a function of distance along the transmission line from the load. The valleys of the standing-wave pattern will no longer be zero, and the peak will be less than that of the short/open case.

The significance of standing waves should not go unnoticed. Ohm's law tells us the complex relationship between the incident and reflected signals at the load. Assuming a 50-ohm source, the voltage across a 25-ohm load resistor will be two thirds of the voltage across a 50-ohm load. Hence, the voltage of the reflected signal is one third the voltage of the incident signal and is 180° out of phase with it. However, as we move away from the load toward the source, we find that the phase between the incident and reflected signals changes! The vector sum of the two signals therefore also changes along the line, producing the standing wave pattern. The apparent impedance also changes along the line because the relative amplitude and phase of the incident and reflected waves *at any given point* uniquely determine the measured impedance. For example, if we made a measurement one quarter wavelength away from the 25-ohm load, the results would indicate a 100-ohm load. The standing wave pattern repeats every half wavelength, as does the apparent impedance.

High-Frequency Device Characterization

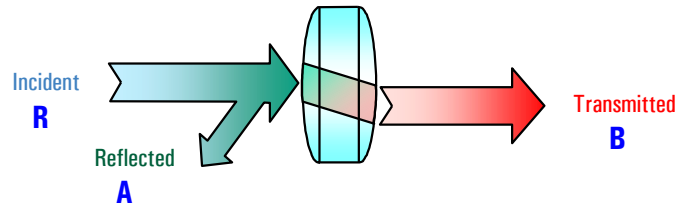

REFLECTION

$$\frac{\text{Reflected}}{\text{Incident}} = \frac{A}{R}$$

- SWR
- S-Parameters S_{11}, S_{22}
- Reflection Coefficient Γ, ρ
- Impedance, Admittance $R + jX, G + jB$
- Return Loss

TRANSMISSION

$$\frac{\text{Transmitted}}{\text{Incident}} = \frac{B}{R}$$

- Gain / Loss
- S-Parameters S_{21}, S_{12}
- Transmission Coefficient T, τ
- Insertion Phase
- Group Delay

Network Analyzer Basics



Agilent Technologies

www.agilent.com/find/backtobasics

Slide 15

Now that we fully understand the relationship of electromagnetic waves, we must also recognize the terms used to describe them. Common network analyzer terminology has the incident wave measured with the R (for reference) receiver. The reflected wave is measured with the A receiver and the transmitted wave is measured with the B receiver. With amplitude and phase information of these three waves, we can quantify the reflection and transmission characteristics of our device under test (DUT). Some of the common measured terms are scalar in nature (the phase part is ignored or not measured), while others are vector (both magnitude and phase are measured). For example, return loss is a scalar measurement of reflection, while impedance results from a vector reflection measurement. Some, like group delay, are purely phase-related measurements.

Ratioed reflection is often shown as A/R and ratioed transmission is often shown as B/R, relating to the measurement receivers used in the network analyzer

Reflection Parameters

Reflection Coefficient

$$\Gamma = \frac{V_{\text{reflected}}}{V_{\text{incident}}} = \rho \angle \Phi = \frac{Z_L - Z_0}{Z_L + Z_0}$$

Return loss = $-20 \log(\rho)$, $\rho = |\Gamma|$

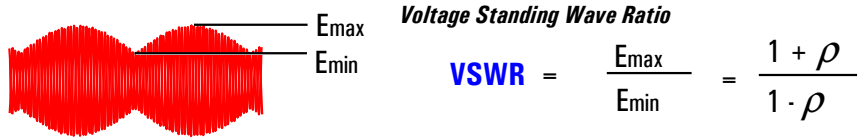

No reflection
($Z_L = Z_0$)

0

∞ dB

1



Full reflection
($Z_L = \text{open, short}$)

1

0 dB

∞

Network Analyzer Basics



Agilent Technologies

www.agilent.com/find/backtobasics

Slide 16

Let's now examine reflection measurements. The first term for reflected waves is reflection coefficient gamma (Γ). Reflection coefficient is the ratio of the reflected signal voltage to the incident signal voltage. It can be calculated as shown above by knowing the impedances of the transmission line and the load. The magnitude portion of gamma is called rho (ρ). A transmission line terminated in Z_0 will have all energy transferred to the load; hence $V_{\text{refl}} = 0$ and $\rho = 0$. When Z_L is not equal to Z_0 , some energy is reflected and ρ is greater than zero. When Z_L is a short or open circuit, all energy is reflected and $\rho = 1$. The range of possible values for ρ is therefore zero to one.

Since it is often very convenient to show reflection on a logarithmic display, the second way to convey reflection is return loss. Return loss is expressed in terms of dB, and is a scalar quantity. The definition for return loss includes a negative sign so that the return loss value is always a positive number (when measuring reflection on a network analyzer with a log magnitude format, ignoring the minus sign gives the results in terms of return loss). Return loss can be thought of as the number of dB that the reflected signal is below the incident signal. Return loss varies between infinity for a Z_0 impedance and 0 dB for an open or short circuit.

As we have already seen, two waves traveling in opposite directions on the same transmission line cause a "standing wave". This condition can be measured in terms of the voltage-standing-wave ratio (VSWR or SWR for short). VSWR is defined as the maximum value of the RF envelope over the minimum value of the envelope. This value can be computed as $(1 + \rho)/(1 - \rho)$. VSWR can take

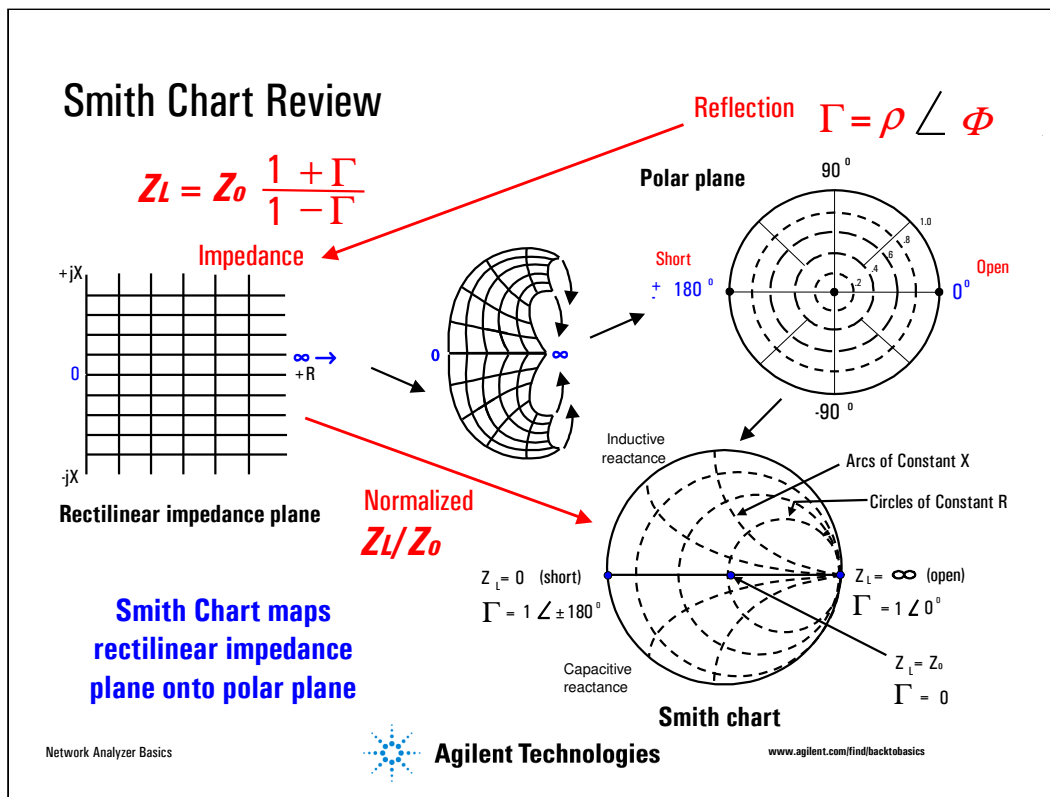

Slide 17

Our network analyzer gives us complex reflection coefficient. However, we often want to know the impedance of the DUT. The previous slide shows the relationship between reflection coefficient and impedance, and we could manually perform the complex math to find the impedance. Although programmable calculators and computers take the drudgery out of doing the math, a single number does not always give us the complete picture. In addition, impedance almost certainly changes with frequency, so even if we did all the math, we would end up with a table of numbers that may be difficult to interpret.

A simple, graphical method solves this problem. Let's first plot reflection coefficient using a polar display. For positive resistance, the absolute magnitude of Γ varies from zero (perfect load) to unity (full reflection) at some angle. So we have a unit circle, which marks the boundary of the polar plane shown on the slide. An open would plot at $1 \angle 0^\circ$; a short at $1 \angle 180^\circ$; a perfect load at the center, and so on. How do we get from the polar data to impedance graphically? Since there is a one-to-one correspondence between complex reflection coefficient and impedance, we can map one plane onto the other. If we try to map the polar plane onto the rectilinear impedance plane, we find that we have problems. First of all, the rectilinear plane does not have values to infinity. Second, circles of constant reflection coefficient are concentric on the polar plane but not on the rectilinear plane, making it difficult to make judgments regarding two different impedances. Finally, phase angles plot as radii on the polar plane but plot as arcs on the rectilinear plane, making it difficult to pinpoint.

The proper solution was first used in the 1930's, when Phillip H. Smith mapped the impedance plane onto the polar plane, creating the chart that bears his name (the venerable *Smith chart*). Since unity at zero degrees on the polar plane represents infinite impedance, both plus and minus infinite reactances, as well as infinite resistance can be plotted. On the Smith chart, the vertical lines on the rectilinear plane that indicate values of constant resistance map to circles, and the horizontal lines that indicate values of constant reactance map to arcs. Z_0 maps to the exact center of the chart.

In general, Smith charts are normalized to Z_0 ; that is, the impedance values are divided by Z_0 . The chart is then independent of the characteristic impedance of the system in question. Actual impedance values are derived by multiplying the indicated value by Z_0 . For example, in a 50-ohm system, a normalized value of $0.3 - j0.15$ becomes $15 - j7.5$ ohms; in a 75-ohm system, $22.5 - j11.25$ ohms.

Fortunately, we no longer have to go through the exercise ourselves. Our network analyzer can display the Smith chart, plot measured data on it, and provide adjustable markers that show the calculated impedance at the marked point in a several marker formats.

Transmission Parameters



$$\text{Transmission Coefficient} = T = \frac{V_{\text{Transmitted}}}{V_{\text{Incident}}} = \tau \angle \phi$$

$$\text{Insertion Loss (dB)} = -20 \text{ Log} \left| \frac{V_{\text{Trans}}}{V_{\text{Inc}}} \right| = -20 \log \tau$$

$$\text{Gain (dB)} = 20 \text{ Log} \left| \frac{V_{\text{Trans}}}{V_{\text{Inc}}} \right| = 20 \log \tau$$

Network Analyzer Basics



www.agilent.com/find/backtobasics

Slide 18

Transmission coefficient T is defined as the transmitted voltage divided by the incident voltage. If $|V_{\text{trans}}| > |V_{\text{inc}}|$, the DUT has gain, and if $|V_{\text{trans}}| < |V_{\text{inc}}|$, the DUT exhibits attenuation or insertion loss. When insertion loss is expressed in dB, a negative sign is added in the definition so that the loss value is expressed as a positive number. The phase portion of the transmission coefficient is called insertion phase.

There is more to transmission than simple gain or loss. In communications systems, signals are time varying -- they occupy a given bandwidth and are made up of multiple frequency components. It is important then to know to what extent the DUT alters the makeup of the signal, thereby causing signal distortion. While we often think of distortion as only the result of nonlinear networks, we will see shortly that linear networks can also cause signal distortion.

Linear Versus Nonlinear Behavior

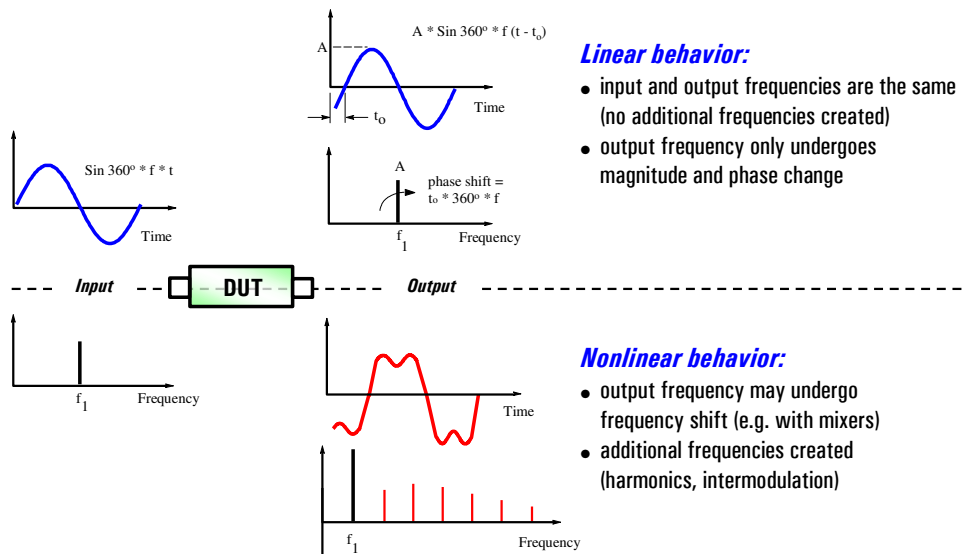

Network Analyzer Basics



www.agilent.com/find/backtobasics

Slide 19

Before we explore linear signal distortion, let's review the differences between linear and nonlinear behavior. Devices that behave linearly only impose magnitude and phase changes on input signals. Any sinusoid appearing at the input will also appear at the output at the same frequency. No new signals are created. When a single sinusoid is passed through a linear network, we don't consider amplitude and phase changes as distortion. However, when a complex, time-varying signal is passed through a linear network, the amplitude and phase shifts can dramatically distort the time-domain waveform.

Non-linear devices can shift input signals in frequency (a mixer for example) and/or create new signals in the form of harmonics or intermodulation products. Many components that behave linearly under most signal conditions can exhibit nonlinear behavior if driven with a large enough input signal. This is true for both passive devices like filters and even connectors, and active devices like amplifiers

Criteria for Distortionless Transmission

Linear Networks

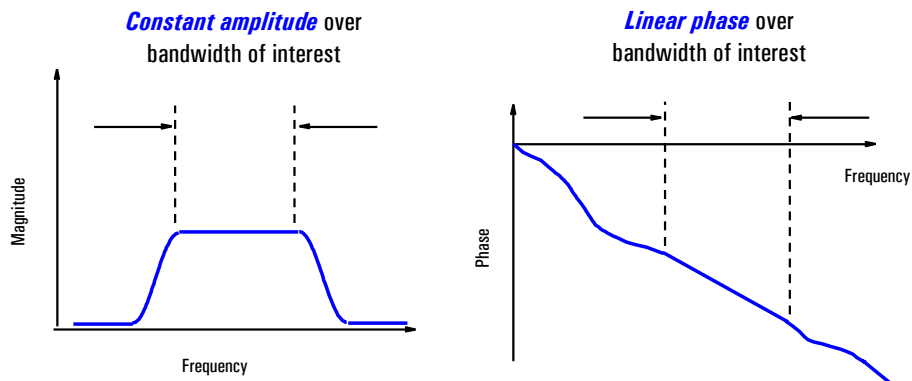

Network Analyzer Basics



www.agilent.com/find/backtobasics

Slide 20

Now let's examine how linear networks can cause signal distortion. There are three criteria that must be satisfied for linear *distortionless* transmission. First, the amplitude (magnitude) response of the device or system must be flat over the bandwidth of interest. This means all frequencies within the bandwidth will be attenuated identically. Second, the phase response must be linear over the bandwidth of interest. And last, the device must exhibit a "minimum-phase response", which means that at 0 Hz (DC), there is 0° phase shift ($0^\circ \pm n \cdot 180^\circ$ is okay if we don't mind an inverted signal).

How can magnitude and phase distortion occur? The following two examples will illustrate how both magnitude and phase responses can introduce linear signal distortion.

Magnitude Variation with Frequency

$$F(t) = \sin \omega t + \frac{1}{3} \sin 3\omega t + \frac{1}{5} \sin 5\omega t$$

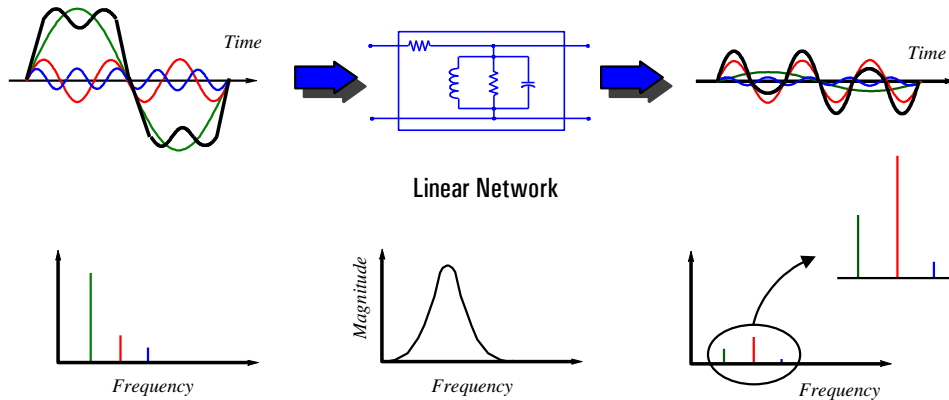

Network Analyzer Basics

 **Agilent Technologies**

www.agilent.com/find/backtobasics

Slide 21

Here is an example of a square wave (consisting of three sinusoids) applied to a bandpass filter. The filter imposes a non-uniform amplitude change to each frequency component. Even though no phase changes are introduced, the frequency components no longer sum to a square wave at the output. The square wave is now severely distorted, having become more sinusoidal in nature.

Phase Variation with Frequency

$$F(t) = \sin \omega t + \frac{1}{3} \sin 3\omega t + \frac{1}{5} \sin 5\omega t$$

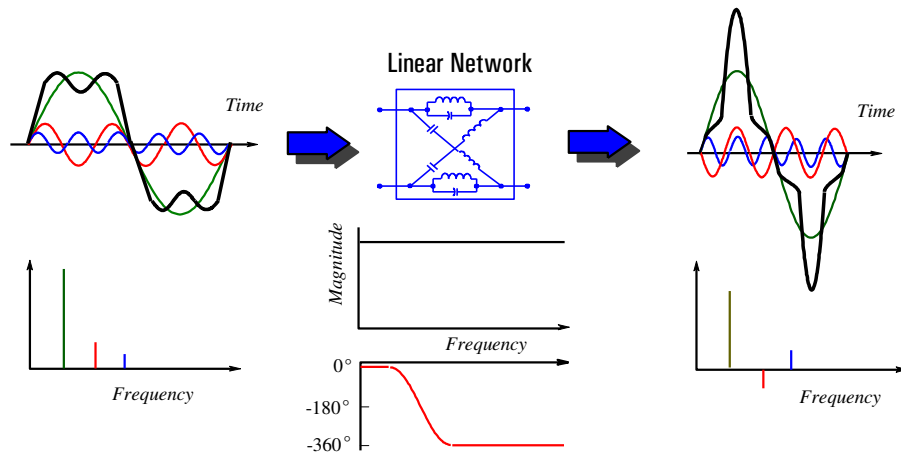

Network Analyzer Basics

 **Agilent Technologies**

www.agilent.com/find/backtobasics

Slide 22

Let's apply the same square wave to another filter. Here, the third harmonic undergoes a 180° phase shift, but the other components are not phase shifted. All the amplitudes of the three spectral components remain the same (filters which only affect the phase of signals are called allpass filters). The output is again distorted, appearing very impulsive this time.

Deviation from Linear Phase

Use electrical delay to remove linear portion of phase response

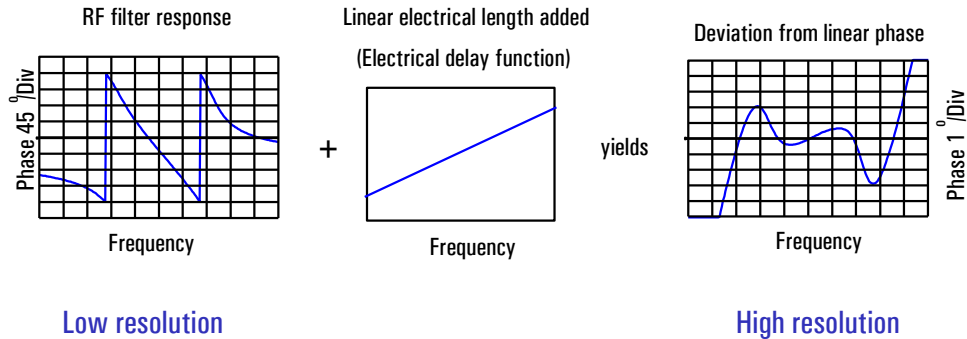

Network Analyzer Basics

 **Agilent Technologies**

www.agilent.com/find/backtobasics

Slide 23

Now that we know insertion phase versus frequency is a very important characteristic of a component, let's see how we would measure it. Looking at insertion phase directly is usually not very useful. This is because the phase has a negative slope with respect to frequency due to the electrical length of the device (the longer the device, the greater the slope). Since it is only the deviation from linear phase which causes distortion, it is desirable to remove the linear portion of the phase response. This can be accomplished by using the electrical delay feature of the network analyzer to cancel the electrical length of the DUT. This results in a high-resolution display of phase distortion (deviation from linear phase).

Group Delay

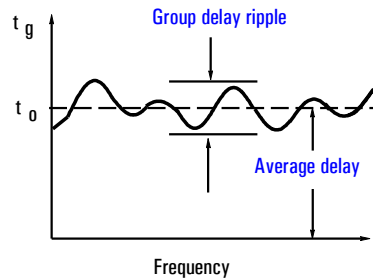
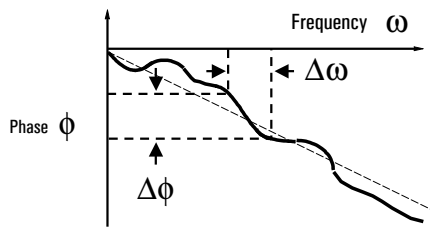

Group Delay (t_g) =

$$\frac{-d\phi}{d\omega} = \frac{-1}{360^\circ} * \frac{d\phi}{df}$$

ϕ in radians

ω in radians/sec

ϕ in degrees

f in Hertz ($\omega = 2\pi f$)

- group-delay ripple indicates phase distortion
- average delay indicates electrical length of DUT
- aperture of measurement is very important

Network Analyzer Basics



Agilent Technologies

www.agilent.com/find/backtobasics

Slide 24

Another useful measure of phase distortion is group delay. Group delay is a measure of the transit time of a signal through the device under test, versus frequency. Group delay is calculated by differentiating the insertion-phase response of the DUT versus frequency. Another way to say this is that group delay is a measure of the slope of the transmission phase response. The linear portion of the phase response is converted to a constant value (representing the average signal-transit time) and deviations from linear phase are transformed into deviations from constant group delay. The variations in group delay cause signal distortion, just as deviations from linear phase cause distortion. Group delay is just another way to look at linear phase distortion.

When specifying or measuring group delay, it is important to quantify the aperture in which the measurement is made. The aperture is defined as the frequency delta used in the differentiation process (the denominator in the group-delay formula). As we widen the aperture, trace noise is reduced but less group-delay resolution is available (we are essentially averaging the phase response over a wider window). As we make the aperture more narrow, trace noise increases but we have more measurement resolution.

Why Measure Group Delay?

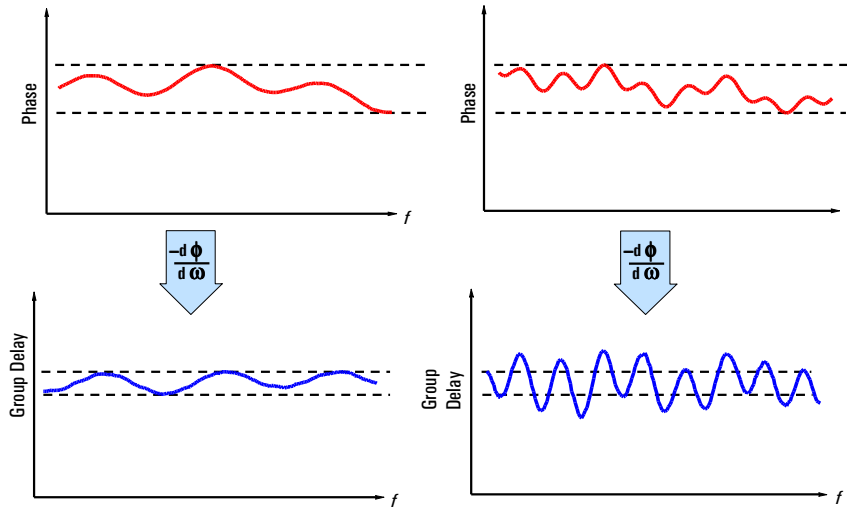

Same p-p phase ripple can result in different group delay

Network Analyzer Basics

 Agilent Technologies

www.agilent.com/find/backtobasics

Slide 25

Why are both deviation from linear phase and group delay commonly measured? Depending on the device, both may be important. Specifying a maximum peak-to-peak value of phase ripple is not sufficient to completely characterize a device since the slope of the phase ripple is dependent on the number of ripples which occur over a frequency range of interest. Group delay takes this into account since it is the differentiated phase response. Group delay is often a more easily interpreted indication of phase distortion.

The plot above shows that the same value of peak-to-peak phase ripple can result in substantially different group delay responses. The response on the right with the larger group-delay variation would cause more signal distortion.

Characterizing Unknown Devices

Using parameters (H, Y, Z, S) to characterize devices:

- gives linear behavioral model of our device
- measure parameters (e.g. voltage and current) versus frequency under various source and load conditions (e.g. short and open circuits)
- compute device parameters from measured data
- predict circuit performance under any source and load conditions

H-parameters

$$V_1 = h_{11}I_1 + h_{12}V_2$$

$$I_2 = h_{21}I_1 + h_{22}V_2$$

Y-parameters

$$I_1 = y_{11}V_1 + y_{12}V_2$$

$$I_2 = y_{21}V_1 + y_{22}V_2$$

Z-parameters

$$V_1 = z_{11}I_1 + z_{12}I_2$$

$$V_2 = z_{21}I_1 + z_{22}I_2$$



$$h_{11} = \left. \frac{V_1}{I_1} \right|_{V_2=0} \quad (\text{requires short circuit})$$

$$h_{12} = \left. \frac{V_1}{V_2} \right|_{I_1=0} \quad (\text{requires open circuit})$$

Network Analyzer Basics



Agilent Technologies

www.agilent.com/find/backtobasics

Slide 26

In order to completely characterize an unknown linear two-port device, we must make measurements under various conditions and compute a set of parameters. These parameters can be used to completely describe the electrical behavior of our device (or network), even under source and load conditions other than when we made our measurements. For low-frequency characterization of devices, the three most commonly measured parameters are the H, Y and Z-parameters. All of these parameters require measuring the total voltage or current as a function of frequency at the input or output nodes (ports) of the device. Furthermore, we have to apply either open or short circuits as part of the measurement. Extending measurements of these parameters to high frequencies is not very practical.

Why Use S-Parameters?

- relatively easy to **obtain** at high frequencies
 - measure voltage traveling waves with a vector network analyzer
 - don't need shorts/opens which can cause active devices to oscillate or self-destruct
- relate to **familiar** measurements (gain, loss, reflection coefficient ...)
- can **cascade** S-parameters of multiple devices to predict system performance
- can **compute** H, Y, or Z parameters from S-parameters if desired
- can easily import and use S-parameter files in our **electronic-simulation** tools

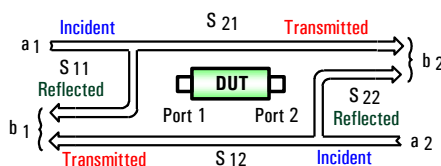
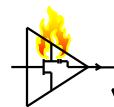

$$b_1 = S_{11} a_1 + S_{12} a_2$$

$$b_2 = S_{21} a_1 + S_{22} a_2$$

Network Analyzer Basics



www.agilent.com/find/backtobasics

Slide 27

At high frequencies, it is very hard to measure total voltage and current at the device ports. One cannot simply connect a voltmeter or current probe and get accurate measurements due to the impedance of the probes themselves and the difficulty of placing the probes at the desired positions. In addition, active devices may oscillate or self-destruct with the connection of shorts and opens.

Clearly, some other way of characterizing high-frequency networks is needed that doesn't have these drawbacks. That is why scattering or S-parameters were developed. S-parameters have many advantages over the previously mentioned H, Y or Z-parameters. They relate to familiar measurements such as gain, loss, and reflection coefficient. They are defined in terms of voltage traveling waves, which are relatively easy to measure. S-parameters don't require connection of undesirable loads to the device under test. The measured S-parameters of multiple devices can be cascaded to predict overall system performance. If desired, H, Y, or Z-parameters can be derived from S-parameters. And very important for RF design, S-parameters are easily imported and used for circuit simulations in electronic-design automation (EDA) tools like Agilent's Advanced Design System (ADS). S-parameters are the shared language between simulation and measurement.

An N-port device has N^2 S-parameters. So, a two-port device has four S-parameters. The numbering convention for S-parameters is that the first number following the "S" is the port where the signal emerges, and the second number is the port where the signal is applied. So, S21 is a measure of the signal coming out port 2 relative to the RF stimulus entering port 1. When the numbers are the same (e.g., S11), it indicates a reflection measurement, as the input and output ports are the same. The incident terms (a_1 , a_2) and output terms (b_1 , b_2) represent voltage traveling waves.

Measuring S-Parameters

$$b_1 = S_{11} a_1 + S_{12} a_2$$

$$b_2 = S_{21} a_1 + S_{22} a_2$$

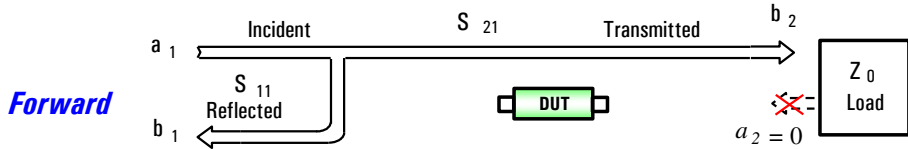

$$S_{11} = \frac{\text{Reflected}}{\text{Incident}} = \frac{b_1}{a_1} \Big|_{a_2 = 0}$$

$$S_{21} = \frac{\text{Transmitted}}{\text{Incident}} = \frac{b_2}{a_1} \Big|_{a_2 = 0}$$

$$S_{22} = \frac{\text{Reflected}}{\text{Incident}} = \frac{b_2}{a_2} \Big|_{a_1 = 0}$$

$$S_{12} = \frac{\text{Transmitted}}{\text{Incident}} = \frac{b_1}{a_2} \Big|_{a_1 = 0}$$

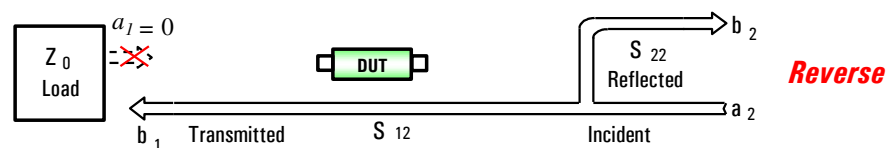

Slide 28

S11 and S21 are determined by measuring the magnitude and phase of the incident, reflected and transmitted voltage signals when the output is terminated in a perfect Z₀ (a load that equals the characteristic impedance of the test system). This condition guarantees that a₂ is zero, since there is no reflection from an ideal load. S11 is equivalent to the input complex reflection coefficient or impedance of the DUT, and S21 is the forward complex transmission coefficient. Likewise, by placing the source at port 2 and terminating port 1 in a perfect load (making a₁ zero), S22 and S12 measurements can be made. S22 is equivalent to the output complex reflection coefficient or output impedance of the DUT, and S12 is the reverse complex transmission coefficient.

The accuracy of S-parameter measurements depends greatly on how good a termination we apply to the load port (the port not being stimulated). Anything other than a perfect load will result in a₁ or a₂ not being zero (which violates the definition for S-parameters). When the DUT is connected to the test ports of a network analyzer and we don't account for imperfect test-port match, we have not done a very good job satisfying the condition of a perfect termination. For this reason, two-port error correction, which corrects for source and load match, is very important for accurate S-parameter measurements (two-port correction is covered in the calibration section).

Equating S-Parameters with Common Measurement Terms

S11 = forward reflection coefficient (*input match*)
S22 = reverse reflection coefficient (*output match*)
S21 = forward transmission coefficient (*gain or loss*)
S12 = reverse transmission coefficient (*isolation*)

Remember, S-parameters are inherently complex, linear quantities -- however, we often express them in a log-magnitude format

Slide 29

S-parameters are essentially the same parameters as some of the terms we have mentioned before, such as input match and insertion loss. It is important to separate the fundamental definition of S-parameters and the format in which they are often displayed. S-parameters are inherently complex, linear quantities. They are expressed as real-and-imaginary or magnitude-and-phase pairs. However, it isn't always very useful to view them as linear pairs. Often we want to look only at the magnitude of the S-parameter (for example, when looking at insertion loss or input match), and often, a logarithmic display is most useful. A log-magnitude format lets us see far more dynamic range than a linear format.

Criteria for Distortionless Transmission

Nonlinear Networks

- Saturation, crossover, intermodulation, and other nonlinear effects can cause signal distortion
- Effect on system depends on amount and type of distortion and system architecture

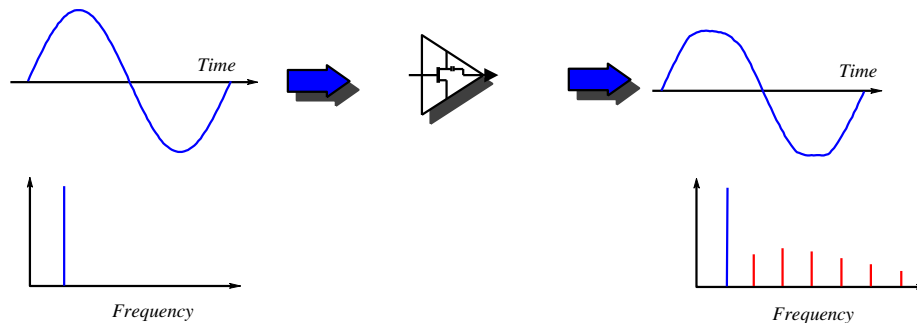

Network Analyzer Basics



www.agilent.com/find/backtobasics

Slide 30

We have just seen how linear networks can cause distortion. Devices which behave nonlinearly also introduce distortion. The example above shows an amplifier that is overdriven, causing the signal at the output to "clip" due to saturation in the amplifier. Because the output signal is no longer a pure sinusoid, harmonics are present at integer multiples of the input frequency.

Passive devices can also exhibit nonlinear behavior at high power levels. A common example is an L-C filter that uses inductors made with magnetic cores. Magnetic materials often display hysteresis effects, which are highly nonlinear. Another example are the connectors used in the antenna path of a cellular-phone base station. The metal-to-metal contacts (especially if water and corrosion salts are present) combined with the high-power transmitted signals can cause a diode effect to occur, producing very low-level intermodulation products. Although the level of the intermodulation products is usually quite small, they can be significant compared to the low signal strength of the received signals, causing interference problems.

What is the Difference Between *Network* and *Spectrum* Analyzers?

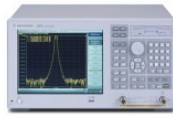
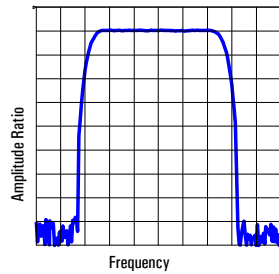

Measures
known signal

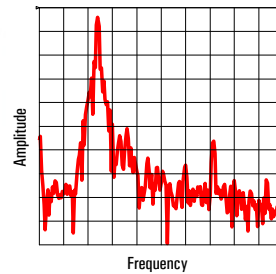

Measures
unknown
signals

Network analyzers:

- measure components, devices, circuits, sub-assemblies
- contain source and receiver
- display ratioed amplitude and phase (frequency or power sweeps)
- offer advanced error correction

Spectrum analyzers:

- measure signal amplitude characteristics (carrier level, sidebands, harmonics...)
- can demodulate (& measure) complex signals
- are receivers only (single channel)
- can be used for scalar component test (*no phase*) with tracking gen. or ext. source(s)

Network Analyzer Basics



Agilent Technologies

www.agilent.com/find/backtobasics

Slide 31

Now that we have seen some of the measurements that are commonly done with network and spectrum analyzers, it might be helpful to review the main differences between these instruments. Although they often both contain tuned receivers operating over similar frequency ranges, they are optimized for very different measurement applications.

Network analyzers are used to measure components, devices, circuits, and sub-assemblies. They contain both a source and multiple receivers, and generally display *ratioed* amplitude and phase information (frequency or power sweeps). A network analyzer is always looking at a *known* signal (in terms of frequency), since it is a stimulus-response system. With network analyzers, it is harder to get an (accurate) trace on the display, but very easy to interpret the results. With vector-error correction, network analyzers provide much higher measurement accuracy than spectrum analyzers.

Spectrum analyzers are most often used to measure signal characteristics such as carrier level, sidebands, harmonics, phase noise, etc., on *unknown* signals. They are most commonly configured as a single-channel receiver, without a source. Because of the flexibility needed to analyze signals, spectrum analyzers generally have a much wider range of IF bandwidths available than most network analyzers. Spectrum analyzers are often used with external sources for nonlinear stimulus/response testing. When combined with a tracking generator, spectrum analyzers can be used for scalar component testing (magnitude versus frequency, but no phase measurements). With spectrum analyzers, it is easy to get a trace on the display, but interpreting the results can be much more difficult than with a network analyzer.

Agenda

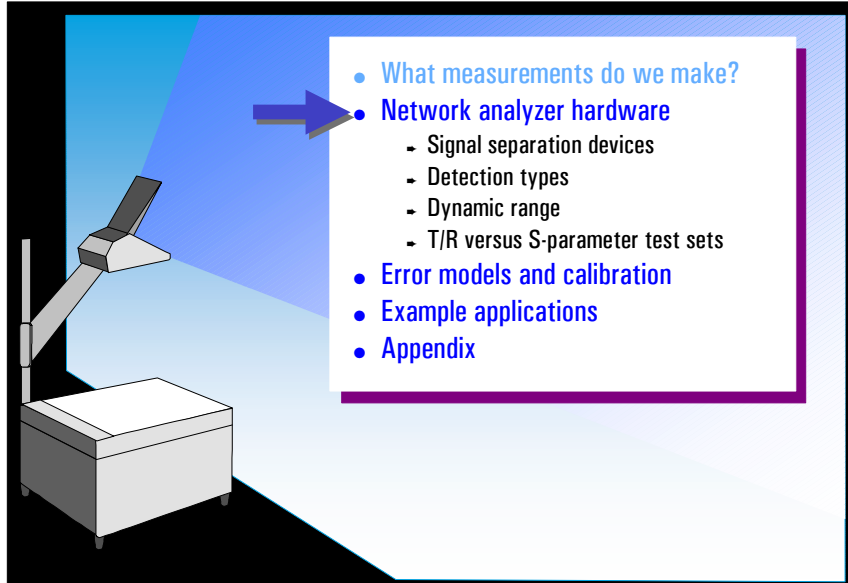

Network Analyzer Basics



www.agilent.com/find/backtobasics

Slide 32

In this next section, we will look at the main parts of a network analyzer.

Generalized Network Analyzer Block Diagram

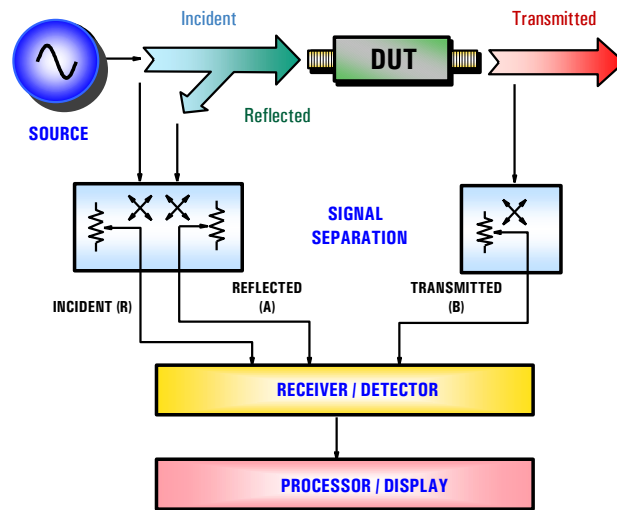

Network Analyzer Basics



www.agilent.com/find/backtobasics

Slide 33

Here is a generalized block diagram of a network analyzer, showing the major signal-processing sections. In order to measure the incident, reflected and transmitted signal, four sections are required:

- Source for stimulus
- Signal-separation devices
- Receivers that downconvert and detect the signals
- Processor/display for calculating and reviewing the results

We will briefly examine each of these sections. More detailed information about the signal separation devices and receiver section are in the appendix.

Source

- Supplies stimulus for system
- Swept frequency or power
- Traditionally NAs used separate source
- Most Agilent analyzers sold today have *integrated, synthesized* sources

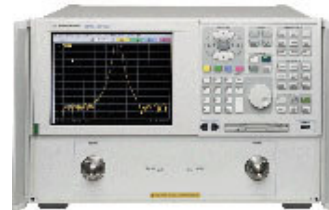
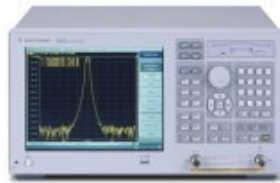
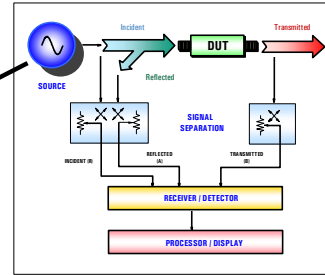

Network Analyzer Basics

 **Agilent Technologies**

www.agilent.com/find/backtobasics

Slide 34

The signal source supplies the stimulus for our stimulus-response test system. We can either sweep the frequency of the source or sweep its power level. Traditionally, network analyzers used a separate source. These sources were either based on open-loop voltage-controlled oscillators (VCOs) which were cheaper, or more expensive synthesized sweepers which provided higher performance, especially for measuring narrowband devices. Excessive phase noise on open-loop VCOs degrades measurement accuracy considerably when measuring narrowband components over small frequency spans. Most network analyzers that Agilent sells today have integrated, synthesized sources, providing excellent frequency resolution and stability.

Signal Separation

- measure incident signal for reference
- separate incident and reflected signals

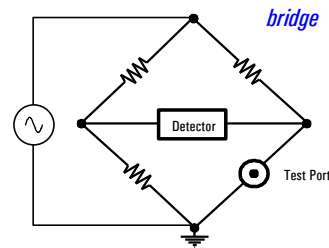
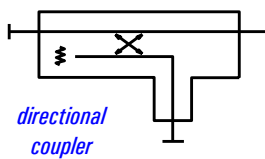
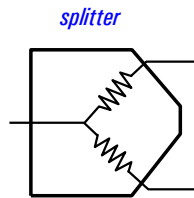
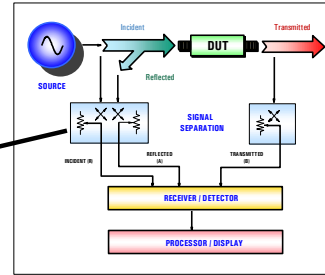

Network Analyzer Basics

 Agilent Technologies

www.agilent.com/find/backtobasics

Slide 35

The next major area we will cover is the signal separation block. The hardware used for this function is generally called the "test set". The test set can be a separate box or integrated within the network analyzer. There are two functions that our signal-separation hardware must provide. The first is to measure a portion of the incident signal to provide a reference for ratioing. This can be done with splitters or directional couplers. Splitters are usually resistive. They are non-directional devices (more on directionality later) and can be very broadband. The trade-off is that they usually have 6 dB or more of loss in each arm. Directional couplers have very low insertion loss (through the main arm) and good isolation and directivity. They are generally used in microwave network analyzers, but their inherent high-pass response makes them unusable below 10 MHz or so.

The second function of the signal-splitting hardware is to separate the incident (forward) and reflected (reverse) traveling waves at the input of our DUT. Again, couplers are ideal in that they are directional, have low loss, and high reverse isolation. However, due to the difficulty of making truly broadband couplers, bridges are often used instead. Bridges work down to DC, but have more loss, resulting in less signal power delivered to the DUT. See the appendix for a more complete description of how a directional bridge works.

Directivity

Directivity is a measure of how well a coupler can separate signals moving in opposite directions

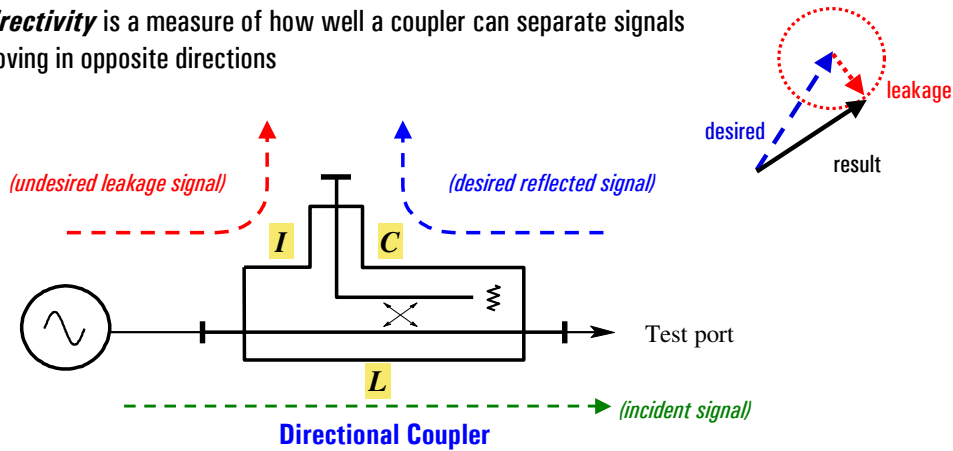

$$\text{Directivity} = \text{Isolation (I)} - \text{Fwd Coupling (C)} - \text{Main Arm Loss (L)}$$

Network Analyzer Basics

 Agilent Technologies

www.agilent.com/find/backtobasics

Slide 36

Unfortunately, real signal-separation devices are never perfect. For example, let's take a closer look at the actual performance of a 3-port directional coupler.

Ideally, a signal traveling in the coupler's reverse direction will not appear at all at the coupled port. In reality, however, some energy does leak through to the coupled arm, as a result of finite isolation (I).

One of the most important parameter for couplers is their directivity. Directivity is a measure of a coupler's ability to separate signals flowing in opposite directions within the coupler. It can be thought of as the dynamic range available for reflection measurements. Directivity can be defined as:

$$\text{Directivity (dB)} = \text{Isolation (dB)} - \text{Forward Coupling Factor (dB)} - \text{Loss (through-arm) (dB)}$$

The appendix contains a slide showing how adding attenuation to the ports of a coupler can affect the effective directivity of a system (such as a network analyzer) that uses a directional coupler.

As we will see in the next slide, finite directivity adds error to our measured results.

Interaction of Directivity with the DUT (Without Error Correction)

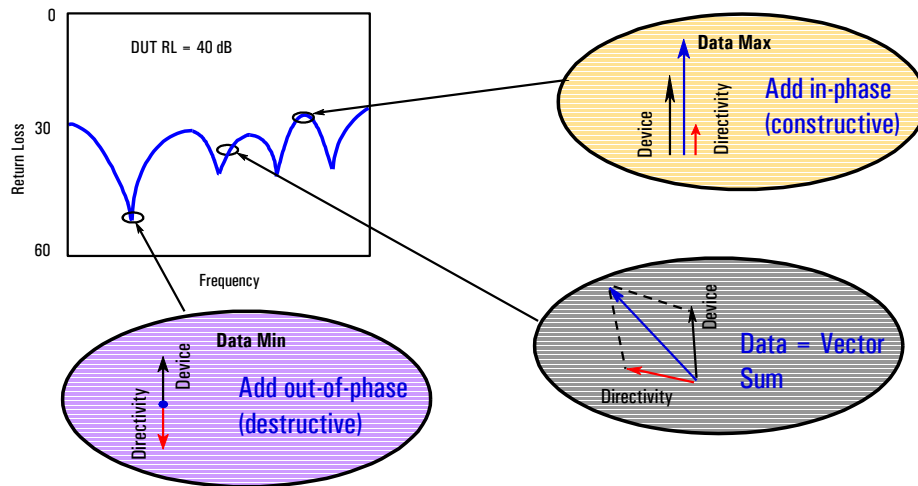

Network Analyzer Basics

 **Agilent Technologies**

www.agilent.com/find/backtobasics

Slide 37

Directivity error is the main reason we see a large ripple pattern in many measurements of return loss. At the peaks of the ripple, directivity is adding in phase with the reflection from the DUT. In some cases, directivity will cancel the DUT's reflection, resulting in a sharp dip in the response.

Detector Types

Diode - Scalar broadband (no phase information)

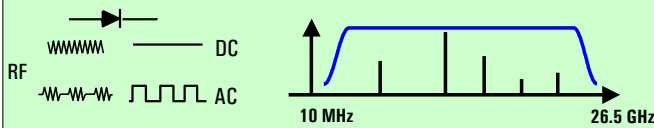

- Inexpensive compared to tuned receiver
- Medium sensitivity / dynamic range
- Improve dynamic range by increasing power
- Good for measuring frequency-translating devices

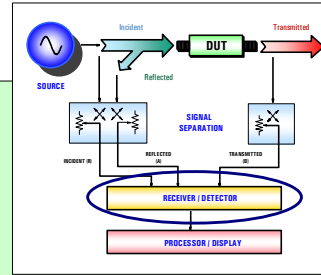

Tuned Receiver - Vector (magnitude and phase)

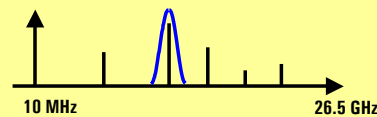
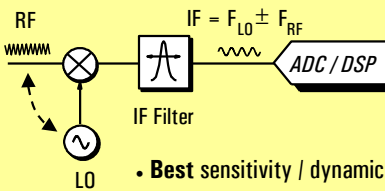

- Best sensitivity / dynamic range
- Provides harmonic / spurious rejection
- Trade off noise floor & measurement speed
- Improve dynamic range by increasing power, decreasing IF bandwidth, or averaging

Network Analyzer Basics



www.agilent.com/find/backtobasics

Slide 38

The next portion of the network analyzer we'll look at is the signal-detection block. There are two basic ways of providing signal detection in network analyzers. Diode detectors convert the RF signal level to a proportional DC level. If the stimulus signal is amplitude modulated, the diode strips the RF carrier from the modulation (this is called AC detection). Diode detection is inherently scalar, as phase information of the RF carrier is lost.

The two main advantages of diode detectors are that they provide broadband frequency coverage (< 10 MHz on the low end to > 26.5 GHz at the high end) and they are inexpensive compared to a tuned receiver. Diode detectors provide medium sensitivity and dynamic range: they can measure signals to -60 dBm or so and have a dynamic range around 60 to 75 dB, depending on the detector type. Their broadband nature limits their sensitivity and makes them sensitive to source harmonics and other spurious signals. Dynamic range is improved in measurements by increasing input power.

AC detection eliminates the DC drift of the diode as an error source, resulting in more accurate measurements. This scheme also reduces noise and other unwanted signals. The major benefit of DC detection is that there is no modulation of the RF signal, which can have adverse effects on the measurement of some devices. Examples include amplifiers with AGC or large DC gain, and narrowband filters.

One application where broadband diode detectors are very useful is measuring frequency-translating devices, particularly those with internal LOs.

The tuned receiver uses a local oscillator (LO) to mix the RF down to a lower "intermediate" frequency (IF). The LO is either locked to the RF or the IF signal so that the receivers in the network analyzer are always tuned to the RF signal present at the input. The IF signal is bandpass filtered, which narrows the receiver bandwidth and greatly improves sensitivity and dynamic range. Modern analyzers use an analog-to-digital converter (ADC) and digital-signal processing (DSP) to extract magnitude and phase information from the IF signal. The tuned-receiver approach is used in vector network analyzers and spectrum analyzers.

Tuned receivers provide the best sensitivity and dynamic range, and also provide harmonic and spurious-signal rejection. The narrow IF filter produces a considerably lower noise floor, resulting in a significant sensitivity improvement. For example, a microwave vector network analyzer (using a tuned receiver) might have a 3 kHz IF bandwidth, where a scalar analyzer's diode detector noise bandwidth might be 26.5 GHz. Measurement dynamic range is improved with tuned receivers by increasing input power, by decreasing IF bandwidth, or by averaging. The latter two techniques provide a trade off between noise floor and measurement speed. Averaging reduces the noise floor of the network analyzer (as opposed to just reducing the noise excursions as happens when averaging spectrum analyzer data) because we are averaging complex data. Without phase information, averaging does not improve analyzer sensitivity.

The same narrowband nature of tuned receivers that produces increased dynamic range also eliminates harmonic and spurious responses. As was mentioned earlier, the RF signal is downconverted and filtered before it is measured. The harmonics associated with the source are also downconverted, but they appear at frequencies outside the IF bandwidth and are therefore removed by filtering.

Dynamic Range and Accuracy

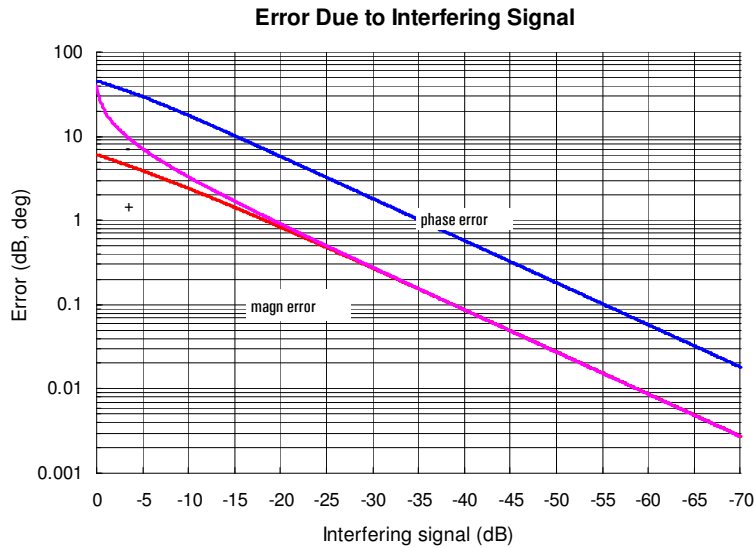

Dynamic range is very important for measurement accuracy!

Network Analyzer Basics



www.agilent.com/find/backtobasics

Slide 39

This plot shows the effect that interfering signals (sinusoids or noise) have on measurement accuracy. The magnitude error is calculated as $20 \cdot \log [1 \pm \text{interfering-signal}]$ and the phase error is calculated as $\text{arc-tangent} [\text{interfering-signal}]$, where the interfering signal is expressed in linear terms. Note that a 0 dB interfering signal results in (plus) 6 dB error when it adds in phase with the desired signal, and (negative) infinite error when it cancels the desired signal.

To get low measurement uncertainty, more dynamic range is needed than the device exhibits. For example, to get less than 0.1 dB magnitude error and less than 0.6 degree phase error, our noise floor needs to be more than 39 dB below our measured power levels (note that there are other sources of error besides noise that may limit measurement accuracy). To achieve that level of accuracy while measuring 80 dB of rejection would require 119 dB of dynamic range. One way to achieve this level is to average test data using a tuned-receiver based network analyzer.

T/R Versus S-Parameter Test Sets

Transmission/Reflection Test Set

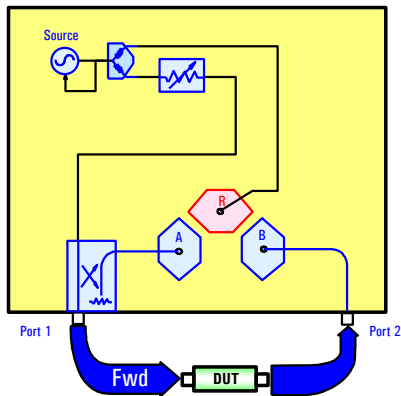

- RF always comes out port 1
- port 2 is always receiver
- **response, one-port cal available**

S-Parameter Test Set

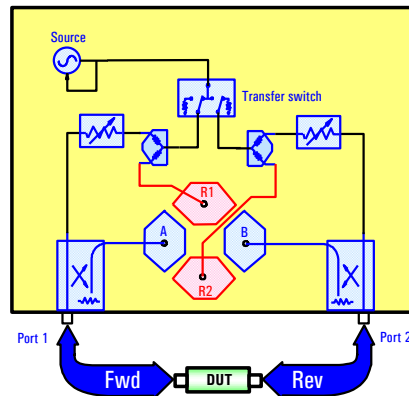

- RF comes out port 1 or port 2
- forward and reverse measurements
- **two-port calibration possible**

Network Analyzer Basics



Agilent Technologies

www.agilent.com/find/backtobasics

Slide 40

There are two basic types of test sets that are used with network analyzers. For transmission/reflection (T/R) test sets, the RF power always comes out of test port one and test port two is always connected to a receiver in the analyzer. To measure reverse transmission or output reflection of the DUT, we must disconnect it, turn it around, and re-connect it to the analyzer. T/R-based network analyzers offer only response and one-port calibrations, so measurement accuracy is not as good as that which can be achieved with S-parameter test sets. However, T/R-based analyzers are more economical.

S-parameter test sets allow both forward and reverse measurements on the DUT, which are needed to characterize all four S-parameters. RF power can come out of either test port one or two, and either test port can be connected to a receiver. S-parameter test sets also allow full two-port (12-term) error correction, which is the most accurate form available. S-parameter network analyzers provide more performance than T/R-based analyzers, but cost more due to extra RF components in the test set.

There are two different types of transfer switches that can be used in an S-parameter test set: solid-state and mechanical. Solid-state switches have the advantage of infinite lifetimes (assuming they are not damaged by too much power from the DUT). However, they are more lossy so they reduce the maximum output power of the network analyzer. Mechanical switches have very low loss and therefore allow higher output powers. Their main disadvantage is that eventually they wear out (after 5 million cycles or so). When using a network analyzer with mechanical switches, measurements are generally done in single-sweep mode, so the transfer switch is not continuously switching.

Processor / Display

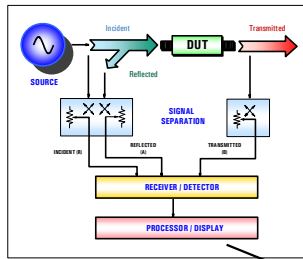

- markers
- limit lines
- pass/fail indicators
- linear/log formats
- grid/polar/Smith charts

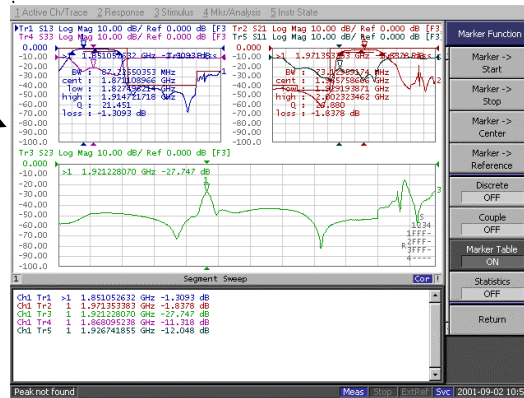
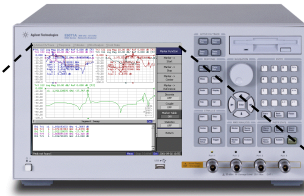

Network Analyzer Basics



Agilent Technologies

www.agilent.com/find/backtobasics

Slide 41

The last major block of hardware in the network analyzer is the display/processor section. This is where the reflection and transmission data is formatted in ways that make it easy to interpret the measurement results. Most network analyzers have similar features such as linear and logarithmic sweeps, linear and log formats, polar plots, Smith charts, etc. Other common features are trace markers, limit lines, and pass/fail testing. Many of Agilent's network analyzers have specialized measurement features tailored to a particular market or application. One example is the E5100A/B, which has features specific to crystal-resonator manufacturers.

Internal Measurement Automation

Simple: recall states

More powerful:

- **Test sequencing**
 - available on 8753 / 8720 families
 - keystroke recording
 - some advanced functions
- **IBASIC**
 - available on legacy 8712/14 family
 - sophisticated programs
 - custom user interfaces
- **Windows-compatible programs**
 - PNA Series - Visual Basic, VEE, LabView, C++, ...
 - ENA Series - Visual Basic Application (VBA)

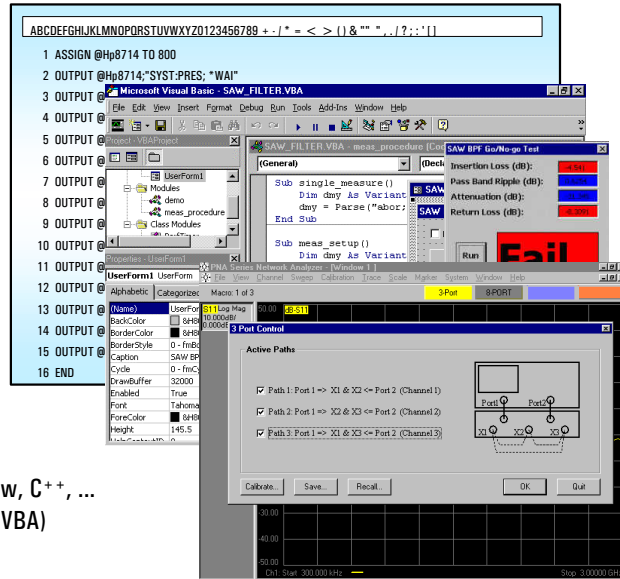

Network Analyzer Basics



www.agilent.com/find/backtobasics

Slide 42

All of Agilent's network analyzers offer some form of internal measurement automation. The most simple form is recall states. This is an easy way to set up the analyzer to a pre-configured measurement state, with all of the necessary instrument parameters.

More powerful automation can be achieved with test sequencing or Instrument BASIC (IBASIC). Test sequencing is available on the 8753/8720 families and provides keystroke recording and some advanced functions. IBASIC is available on the 8712/14 ET/ES series and provides the user with sophisticated programs and custom user interfaces and measurement personalities.

The most powerful automation can be achieved with the ENA and PNA Series of analyzers. These analyzers use Windows operating system. With the PNA, any PC-compatible programming language can be used to create an executable. Popular programming languages such as Visual Basic, Visual C++, Agilent VEE, LabView or even Agilent BASIC for Windows can be used. While a software developer could use the PNA Series instrument as the development PC, it is recommended that program development occur on an external PC, with the end result being a compiled, executable file that would run on the PNA Series analyzer.

The ENA series has built-in Visual Basic Application (VBA) which offers practically real-time data post processing making it ideal for test automation. VBA can also be used to simplify complicated key sequences, perform specific functions such as User defined analysis and data formatting, and ease test development.

Agilent's PNA Series Vector Network Analyzers

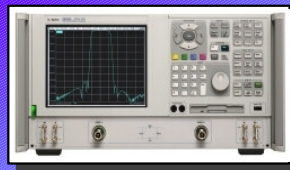

RF PNA Series

- 300 kHz to 3, 6, 9 GHz
- Highest RF performance
- 2-port/4-receiver E835xA
- 2-port/3-receiver E880xA
- 3-port/4-receiver N338xA

PNA Series

- ✓ High performance, speed and accuracy
- ✓ Windows O/S, flexibility
- ✓ Advanced connectivity - USB, LAN, & GPIB
- ✓ Internal automation - SCPI or COM/DCOM

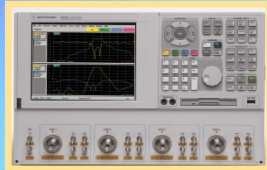

PNA-L Series – N5230A

- 2-Port 6, 13.5, 20, 40, 50 GHz
- 4-Port 20 GHz
- Highest accuracy
- Very low trace noise
- Test balanced devices

PNA Series

- ✓ High dynamic range
- ✓ Very fast sweep times
- ✓ Very low trace noise

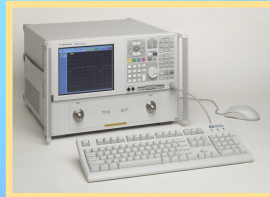

PNA Series – E836xB / E8361A

- 2-Port 10MHz to 20, 40, 50, 67 GHz
- High dynamic range
- Speed & performance
- Test mixers, high-power amps, pulsed, antenna, mmWave

Network Analyzer Basics



Agilent Technologies

www.agilent.com/find/backtobasics

Slide 43

Shown here is a summary of Agilent's PNA series of high performance vector network analyzers.

The PNA offers;

- ✓ Exception performance
 - high dynamic range
 - fast sweeps
 - very low trace noise
- ✓ Advanced connectivity - LAN, USB, GPIB, Parallel, Serial
- ✓ Flexible automation choices - SCPI, COM/DCOM
- ✓ Easy to learn and use;
 - These instruments employ Windows as the operating system, which provides many advantages to older analyzers. For example, the mouse-driven drop-down menus make the analyzers easy to learn and use. For operators used to traditional instruments, we also provide a hardkey/softkey interface.
 - Setting up and displaying measurements is much more flexible than any other network analyzer.
 - Windows provides many connectivity features such as support for LAN and USB interfaces, and it allows a very flexible and powerful automation model for both R&D and manufacturing environments.
- ✓ Many models to choose from, covering RF and Microwave frequencies

For more information:

<http://www.agilent.com/find/rfpna>

<http://www.agilent.com/find/pna>

Agilent's ENA Series of Vector Network Analyzers

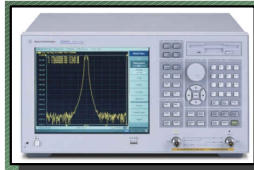

ENA-L Series – E5061A / E5062A

- 300kHz to 1.5 / 3 GHz
- 2-port, T/R or S-Param, 50 or 75 Ω test set
- Lowest cost, fast, flexible
- Built-in VBA
- Fault location & SRL, CATV

ENA Series

- ✓ High dynamic range
- ✓ Fast sweep times
- ✓ Low trace noise

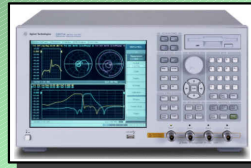

ENA Series – E5070B / E5071B

- 300kHz to 3 / 8.5 GHz
- 2 / 3 / 4 -port, 50 Ω test set
- Ultimate speed & accuracy
- Built-in VBA, Fixture Simulator, Advanced Calibration
- Balanced devices, FOM, time domain

ENA Series

- ✓ Performance, speed and accuracy
- ✓ Windows O/S, enhanced usability
- ✓ Connectivity - USB, LAN, & GPIB
- ✓ Internal automation - VBA

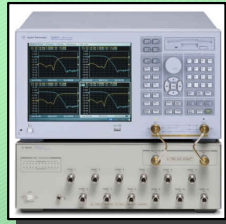

Multiport Test Sets

- ENA-L controls 87075C - 6 or 12 ports, 75 Ω
- ENA has built-in 2, 3, or 4 ports
- ENA controls E5091A - 7 or 9 ports, 50 Ω

Network Analyzer Basics



Agilent Technologies

www.agilent.com/find/backtobasics

Slide 44

The Agilent ENA Series network analyzers offer a wide range of RF solutions from very low cost basic S-parameter measurements to advanced multiport and balanced measurements. The standard ENA analyzers expand network analysis with advanced features, while the lower cost ENA-L analyzers provide basic S-parameter measurements.

The ENA-L provides basic vector network analysis in a wide range of industries and applications such as wireless communications, cable TV, automotive, education, and more. It can be configured to meet your application and budget; frequency coverage to 1.5 or 3 GHz, a T/R or full S-Parameter test set, and choice between 50 or 75 ohm system impedance.

The ENA offers fast and accurate measurements for multiport devices such as duplexers, couplers, and balanced components. Up to four built-in ports are available with an upper frequency range of 3 or 8.5 GHz. It also provides advanced capabilities and features such as balanced and harmonic measurements, mixer measurements & calibrations, embedding/de-embedding and port impedance conversion, and time domain.

For more information: <http://www.agilent.com/find/ena>

Agilent's LF & Other Series of Vector Network Analyzers



Low Frequency (LF) - E5100A/B

- 10kHz to 180 / 300 MHz
- Economical, fast, small
- Applications: crystals, resonators, filters
- Built-in equivalent-circuit models

Combination NA & SA - 4395A/4396B

- 10Hz to 500 MHz (4395A) / 100kHz to 1.8 GHz (4396B)
- Impedance-measuring option
- Fast, FFT-based spectrum analysis with time-gating option
- Internal automation with IBASIC
- Standard test fixtures

8712/14 ET/ES series⁽¹⁾

- 1.3, 3 GHz

(1) Discontinued

8753ET/ES series

- 3, 6 GHz

8719/20/22ET/ES series

- 13.5, 20, 40 GHz

8510C series⁽¹⁾

- 110 GHz in coax

Network Analyzer Basics

 **Agilent Technologies**

www.agilent.com/find/backtobasics

Slide 45

Shown here is a summary of Agilent's lower-frequency vector network analyzer, combination network/spectrum analyzers, and legacy analyzers.

Migration plan for legacy analyzers to new analyzers:

- 8712/14 ET/ES family to the new ENA-L series (E5061A and E5062A)
- 8753 ET/ES family to the new ENA series (E5070B and E5071B)
- 8719/20/22 ET/ES family to the new PNA and PNA-L series (E836xB and N5230A)
- 8510C family to the PNA series (E836xB, E8361A, and N5250A)

Agenda

- What measurements do we make?
- Network analyzer hardware
- Error models and calibration
 - Types of measurement error
 - What is vector error correction ?
 - Calibration types – error models
 - Error-correction choices
 - Basic uncertainty calculations
- Example applications
- Appendix

Why do we even need error-correction and calibration?

- It is impossible to make perfect hardware
- It would be extremely expensive to make hardware good enough to eliminate the need for error correction

Network Analyzer Basics



Agilent Technologies

www.agilent.com/find/backtobasics

Slide 46

In this next section, we will talk about the need for error correction and how it is accomplished. Why do we even need error-correction and calibration? It is impossible to make perfect hardware which obviously would not need any form of error correction. Even making the hardware good enough to eliminate the need for error correction for most devices would be extremely expensive. The best balance is to make the hardware as good as practically possible, balancing performance and cost. Error correction is then a very useful tool to improve measurement accuracy.

We will explain the sources of measurement error, how it can be corrected with calibration, and give accuracy examples using different calibration types.

Measurement Error Modeling



Systematic errors

- due to **imperfections** in the analyzer and test setup
- assumed to be **time invariant** (predictable)



Random errors

- **vary** with time in random fashion (unpredictable)
- main contributors: instrument **noise**, switch and connector **repeatability**



Drift errors

- due to system performance changing **after** a calibration has been done
- primarily caused by **temperature variation**

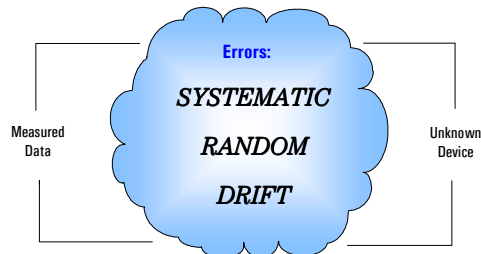

Network Analyzer Basics



Agilent Technologies

www.agilent.com/find/backbasics

Slide 47

Let's look at the three basic sources of measurement error: systematic, random and drift.

Systematic errors are due to imperfections in the analyzer and test setup. They are repeatable (and therefore predictable), and are assumed to be time invariant. Systematic errors are characterized during the calibration process and mathematically removed during measurements.

Random errors are unpredictable since they vary with time in a random fashion. Therefore, they cannot be removed by calibration. The main contributors to random error are instrument noise (source phase noise, sampler noise, IF noise).

Drift errors are due to the instrument or test-system performance changing *after* a calibration has been done. Drift is primarily caused by temperature variation and it can be removed by further calibration(s). The timeframe over which a calibration remains accurate is dependent on the rate of drift that the test system undergoes in the user's test environment. Providing a stable ambient temperature usually goes a long way towards minimizing drift.

Systematic Measurement Errors

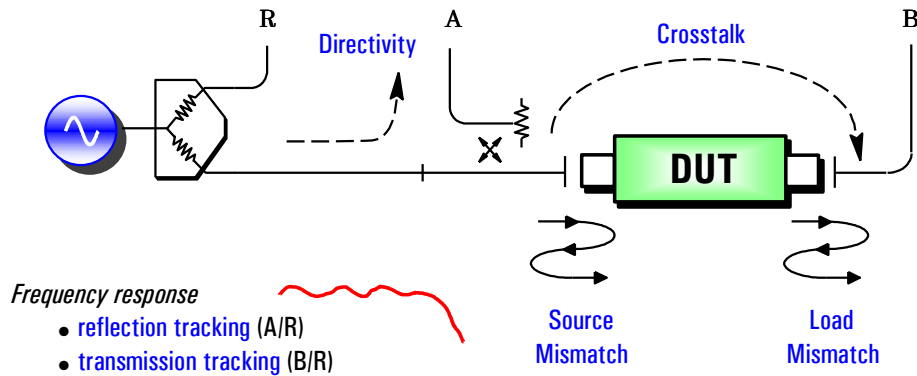

***Six forward and six reverse error terms
yields 12 error terms for two-port devices***

Network Analyzer Basics

 Agilent Technologies

www.agilent.com/find/backtobasics

Slide 48

Shown here are the major systematic errors associated with network measurements. The errors relating to signal leakage are directivity and crosstalk. Errors related to signal reflections are source and load match. The final class of errors are related to frequency response of the receivers, and are called reflection and transmission tracking. The full two-port error model includes all six of these terms for the forward direction and the same six (with different data) in the reverse direction, for a total of twelve error terms. This is why we often refer to two-port calibration as twelve-term error correction

Types of Error Correction

- **response (normalization)**
 - simple to perform
 - only corrects for tracking errors
 - stores reference trace in memory, then does data divided by memory
- **vector**
 - requires more standards
 - requires an analyzer that can measure phase
 - accounts for all major sources of systematic error

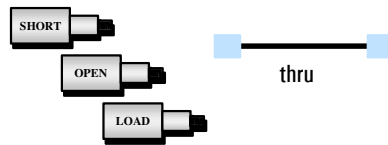
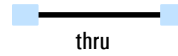
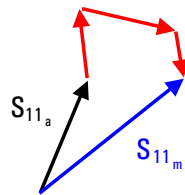

Network Analyzer Basics

 Agilent Technologies

www.agilent.com/find/backtobasics

Slide 49

The two main types of error correction that can be done are response (normalization) corrections and vector corrections. Response calibration is simple to perform, but only corrects for a few of the twelve possible systematic error terms (the tracking terms). Response calibration is essentially a normalized measurement where a reference trace is stored in memory, and subsequent measurement data is divided by this memory trace. A more advanced form of response calibration is open/short averaging for reflection measurements using broadband diode detectors. In this case, two traces are averaged together to derive the reference trace.

Vector-error correction requires an analyzer that can measure both magnitude and phase. It also requires measurements of more calibration standards. Vector-error correction can account for all the major sources of systematic error and can give very accurate measurements.

Note that a response calibration can be performed on a vector network analyzer, in which case we store a complex (vector) reference trace in memory, so that we can display normalized magnitude or phase data. This is not the same as vector-error correction however (and not as accurate), because we are not measuring and removing the individual systematic errors, all of which are complex or vector quantities.

What is Vector-Error Correction?

- Process of characterizing systematic error terms
 - measure **known standards**
 - remove effects from subsequent measurements
- **1-port calibration** (reflection measurements)
 - only 3 systematic error terms measured
 - directivity, source match, and reflection tracking
- **Full 2-port calibration** (reflection and transmission measurements)
 - 12 systematic error terms measured
 - usually requires 12 measurements on four known standards (SOLT)
- Standards defined in cal kit definition file
 - network analyzer contains standard cal kit definitions
 - **CAL KIT DEFINITION MUST MATCH ACTUAL CAL KIT USED!**
 - User-built standards must be characterized and entered into user cal-kit

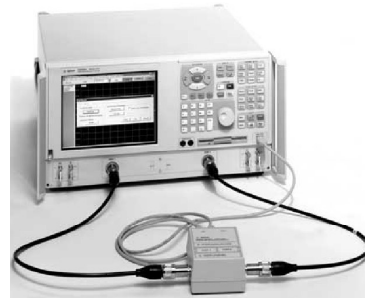

Network Analyzer Basics

 **Agilent Technologies**

www.agilent.com/find/backtobasics

Slide 50

Vector-error correction is the process of characterizing systematic error terms by measuring known calibration standards, and then removing the effects of these errors from subsequent measurements.

One-port calibration is used for reflection measurements and can measure and remove three systematic error terms (directivity, source match, and reflection tracking). Full two-port calibration can be used for both reflection and transmission measurements, and all twelve systematic error terms are measured and removed.

Traditional two-port calibration usually requires twelve measurements on four known standards (short-open-load-through or SOLT). Some standards are measured multiple times (e.g., the through standard is usually measured four times). The standards themselves are defined in a cal-kit definition file, which is stored in the network analyzer. Agilent network analyzers contain all of the cal-kit definitions for our standard calibration kits. In order to make accurate measurements, the cal-kit definition **MUST MATCH THE ACTUAL CALIBRATION KIT USED!** If user-built calibration standards are used (during fixtured measurements for example), then the user must characterize the calibration standards and enter the information into a user cal-kit file. Sources of more information about this topic can be found in the appendix.

Electronic calibration (ECal) replaces the traditional calibration technique, which uses mechanical standards. Mechanical standards require numerous connections to the test ports for a single calibration. These traditional calibrations require intensive operator interaction, which is prone to error. With ECal, a full one- to four-port calibration can be accomplished with a single connection to the ECal module and minimal operator interaction. This results in faster and more repeatable calibrations.

By reducing the number of connections required for a calibration, it can:

- Calibrate faster, save time and make measurements sooner
- Reduce the chance of operator error, for greater confidence in the calibrations
- Reduce the wear on connectors, for lower repair costs on both the test port connectors and calibration standards

Reflection: One-Port Model

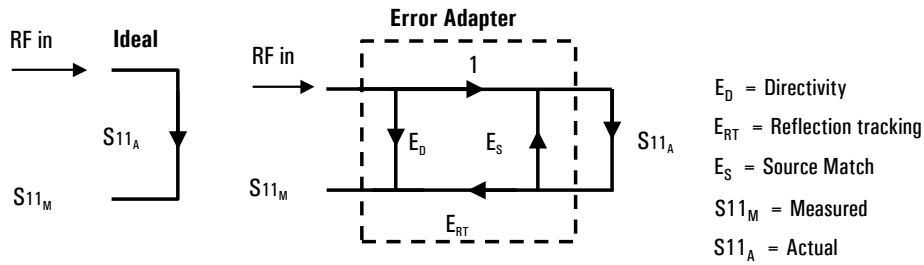

To solve for error terms, we
measure 3 standards to generate
3 equations and 3 unknowns

$$S_{11M} = E_D + E_{RT} \left[\frac{S_{11A}}{1 - E_S S_{11A}} \right]$$

- Assumes good termination at port two if testing two-port devices
- If using port 2 of NA *and* DUT reverse isolation is low (e.g., filter passband):
 - assumption of good termination is not valid
 - two-port error correction yields better results

Network Analyzer Basics



www.agilent.com/find/backtobasics

Slide 51

Taking the simplest case of a one-port reflection measurement, we have three systematic errors and one equation to solve in order to calculate the actual reflection coefficient from the measured value. In order to do this, we must first calculate the individual error terms contained in this equation. We do this by creating three more equations with three unknowns each, and solving them simultaneously. The three equations come from measuring three known calibration standards, for example, a short, an open, and a Z_0 load. Solving the equations will yield the systematic error terms and allow us to derive the actual reflection S-parameter of the device from our measurements.

When measuring reflection two-port devices, a one-port calibration assumes a good termination at port two of the device. If this condition is met (by connecting a load calibration standard for example), the one-port calibration is quite accurate. If port two of the device is connected to the network analyzer and the reverse isolation of the DUT is low (for example, filter passbands or cables), the assumption of a good load termination is not valid. In these cases, two-port error correction provides more accurate measurements. An example of a two-port device where load match is not important is an amplifier. The reverse isolation of the amplifier allows one-port calibration to be used effectively. An example of the measurement error that can occur when measuring a two-port filter using a one-port calibration will be shown shortly.

Before and After One-Port Calibration

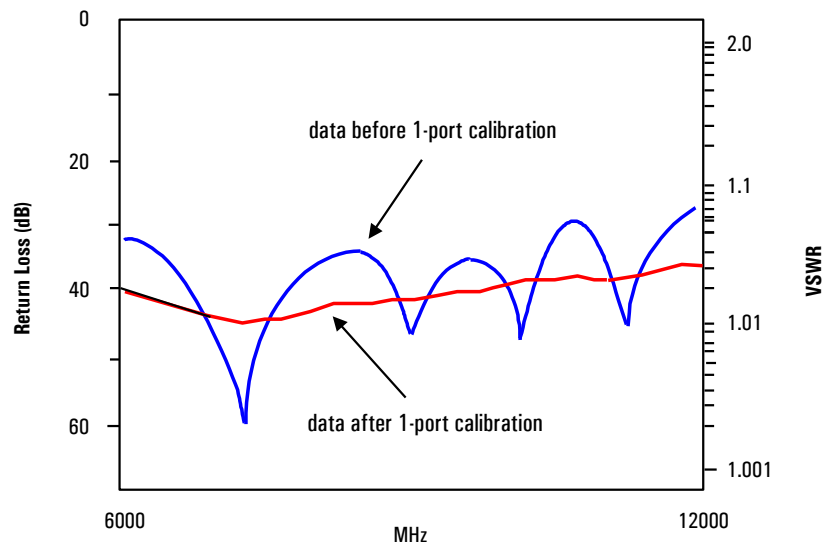

Network Analyzer Basics



www.agilent.com/find/backtobasics

Slide 52

Shown here is a plot of reflection with and without one-port calibration. Without error correction, we see the classic ripple pattern caused by the systematic errors interfering with the measured signal. The error-corrected trace is much smoother and better represents the device's actual reflection performance.

Two-Port Error Correction

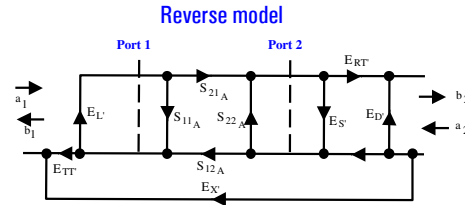
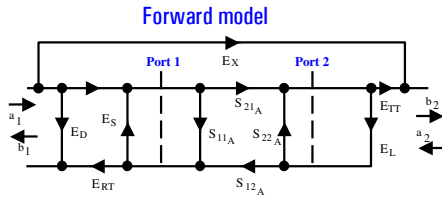

E_D = fwd directivity E_L = fwd load match
 E_S = fwd source match E_{TT} = fwd transmission tracking
 E_{RT} = fwd reflection tracking E_X = fwd isolation
 $E_{D'}$ = rev directivity $E_{L'}$ = rev load match
 $E_{S'}$ = rev source match $E_{TT'}$ = rev transmission tracking
 $E_{RT'}$ = rev reflection tracking $E_{X'}$ = rev isolation

- Each actual S-parameter is a function of all four measured S-parameters
- Analyzer must make forward *and* reverse sweep to update any one S-parameter
- Luckily, you don't need to know these equations to *use* network analyzers!!!

$$S_{11a} = \frac{\left(\frac{S_{11m} - E_D}{E_{RT}}\right) \left(1 + \frac{S_{22m} - E_{D'}}{E_{RT'}} E_{S'}\right) - E_L \left(\frac{S_{21m} - E_X}{E_{TT}}\right) \left(\frac{S_{12m} - E_{X'}}{E_{TT'}}\right)}{\left(1 + \frac{S_{11m} - E_D}{E_{RT}} E_S\right) \left(1 + \frac{S_{22m} - E_{D'}}{E_{RT'}} E_{S'}\right) - E_L' E_L \left(\frac{S_{21m} - E_X}{E_{TT}}\right) \left(\frac{S_{12m} - E_{X'}}{E_{TT'}}\right)}$$

$$S_{21a} = \frac{\left(\frac{S_{21m} - E_X}{E_{TT}}\right) \left(1 + \frac{S_{22m} - E_{D'}}{E_{RT'}} (E_{S'} - E_L)\right)}{\left(1 + \frac{S_{11m} - E_D}{E_{RT}} E_S\right) \left(1 + \frac{S_{22m} - E_{D'}}{E_{RT'}} E_{S'}\right) - E_L' E_L \left(\frac{S_{21m} - E_X}{E_{TT}}\right) \left(\frac{S_{12m} - E_{X'}}{E_{TT'}}\right)}$$

$$S_{12a} = \frac{\left(\frac{S_{12m} - E_{X'}}{E_{TT'}}\right) \left(1 + \frac{S_{11m} - E_D}{E_{RT}} (E_S - E_L')\right)}{\left(1 + \frac{S_{11m} - E_D}{E_{RT}} E_S\right) \left(1 + \frac{S_{22m} - E_{D'}}{E_{RT'}} E_{S'}\right) - E_L' E_L \left(\frac{S_{21m} - E_X}{E_{TT}}\right) \left(\frac{S_{12m} - E_{X'}}{E_{TT'}}\right)}$$

$$S_{22a} = \frac{\left(\frac{S_{22m} - E_{D'}}{E_{RT'}}\right) \left(1 + \frac{S_{11m} - E_D}{E_{RT}} E_S\right) - E_L' \left(\frac{S_{21m} - E_X}{E_{TT}}\right) \left(\frac{S_{12m} - E_{X'}}{E_{TT'}}\right)}{\left(1 + \frac{S_{11m} - E_D}{E_{RT}} E_S\right) \left(1 + \frac{S_{22m} - E_{D'}}{E_{RT'}} E_{S'}\right) - E_L' E_L \left(\frac{S_{21m} - E_X}{E_{TT}}\right) \left(\frac{S_{12m} - E_{X'}}{E_{TT'}}\right)}$$

Network Analyzer Basics



Agilent Technologies

www.agilent.com/find/backtobasics

Slide 53

Two-port error correction is the most accurate form of error correction since it accounts for all of the major sources of systematic error. The error model for a two-port device is shown above. Shown below are the equations to derive the actual device S-parameters from the measured S-parameters, once the systematic error terms have been characterized. Notice that each actual S-parameter is a function of all four measured S-parameters. The network analyzer must make a forward and reverse sweep to update any one S-parameter. Luckily, you don't need to know these equations to use network analyzers!!!

$$S_{11a} = \frac{\left(\frac{S_{11m} - E_D}{E_{RT}}\right) \left(1 + \frac{S_{22m} - E_{D'}}{E_{RT'}} E_{S'}\right) - E_L \left(\frac{S_{21m} - E_X}{E_{TT}}\right) \left(\frac{S_{12m} - E_{X'}}{E_{TT'}}\right)}{\left(1 + \frac{S_{11m} - E_D}{E_{RT}} E_S\right) \left(1 + \frac{S_{22m} - E_{D'}}{E_{RT'}} E_{S'}\right) - E_L' E_L \left(\frac{S_{21m} - E_X}{E_{TT}}\right) \left(\frac{S_{12m} - E_{X'}}{E_{TT'}}\right)}$$

$$S_{21a} = \frac{\left(\frac{S_{21m} - E_X}{E_{TT}}\right) \left(1 + \frac{S_{22m} - E_{D'}}{E_{RT'}} (E_{S'} - E_L)\right)}{\left(1 + \frac{S_{11m} - E_D}{E_{RT}} E_S\right) \left(1 + \frac{S_{22m} - E_{D'}}{E_{RT'}} E_{S'}\right) - E_L' E_L \left(\frac{S_{21m} - E_X}{E_{TT}}\right) \left(\frac{S_{12m} - E_{X'}}{E_{TT'}}\right)}$$

$$S_{12a} = \frac{\left(\frac{S_{12m} - E_{X'}}{E_{TT'}}\right) \left(1 + \frac{S_{11m} - E_D}{E_{RT}} (E_S - E_L')\right)}{\left(1 + \frac{S_{11m} - E_D}{E_{RT}} E_S\right) \left(1 + \frac{S_{22m} - E_{D'}}{E_{RT'}} E_{S'}\right) - E_L' E_L \left(\frac{S_{21m} - E_X}{E_{TT}}\right) \left(\frac{S_{12m} - E_{X'}}{E_{TT'}}\right)}$$

$$S_{22a} = \frac{\left(\frac{S_{22m} - E_{D'}}{E_{RT'}}\right) \left(1 + \frac{S_{11m} - E_D}{E_{RT}} E_S\right) - E_L' \left(\frac{S_{21m} - E_X}{E_{TT}}\right) \left(\frac{S_{12m} - E_{X'}}{E_{TT'}}\right)}{\left(1 + \frac{S_{11m} - E_D}{E_{RT}} E_S\right) \left(1 + \frac{S_{22m} - E_{D'}}{E_{RT'}} E_{S'}\right) - E_L' E_L \left(\frac{S_{21m} - E_X}{E_{TT}}\right) \left(\frac{S_{12m} - E_{X'}}{E_{TT'}}\right)}$$

Crosstalk: Signal Leakage Between Test Ports During Transmission

- Can be a problem with:
 - high-isolation devices (e.g., switch in open position)
 - high-dynamic range devices (some filter stopbands)
- Isolation calibration
 - adds noise to error model (measuring near noise floor of system)
 - only perform if really needed (use averaging if necessary)
 - if crosstalk is **independent** of DUT match, use two terminations
 - if **dependent** on DUT match, use DUT with termination on output

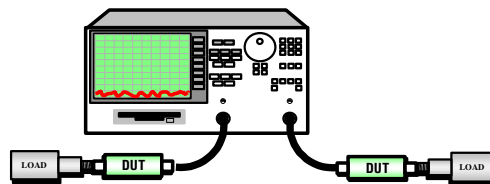
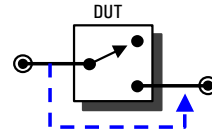

Network Analyzer Basics

 Agilent Technologies

www.agilent.com/find/backtobasics

Slide 54

When performing a two-port calibration, the user has the option of omitting the part of the calibration that characterizes crosstalk or isolation. The definition of crosstalk is the signal leakage between test ports when no device is present. Crosstalk can be a problem with high-isolation devices (e.g., switch in open position) and high-dynamic range devices (some filter stopbands). The isolation calibration adds noise to the error model since we usually are measuring near the noise floor of the system. For this reason, one should only perform the isolation calibration if it is really needed. If the isolation portion of the calibration is done, trace averaging should be used to ensure that the system crosstalk is not obscured by noise. In some network analyzers, crosstalk can be minimized by using the alternate sweep mode instead of the chop mode (the chop mode makes measurements on both the reflection (A) and transmission (B) receivers at each frequency point, whereas the alternate mode turns off the reflection receiver during the transmission measurement).

The best way to perform an isolation calibration is by placing the devices that will be measured on each test port of the network analyzer, with terminations on the other two device ports. Using this technique, the network analyzer sees the same impedance versus frequency during the isolation calibration as it will during subsequent measurements of the DUT. If this method is impractical (in test fixtures, or if only one DUT is available, for example), then placing a terminated DUT on the source port and a termination on the load port of the network analyzer is the next best alternative (the DUT and termination must be swapped for the reverse measurement). If no DUT is available or if the DUT will be tuned (which will change its port matches), then terminations should be placed on each network analyzer test port for the isolation calibration.

Errors and Calibration Standards

UNCORRECTED



- Convenient
- Generally not accurate
- No errors removed

RESPONSE

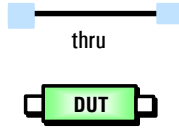

- Easy to perform
- Use when highest accuracy is not required
- Removes frequency response error

1-PORT

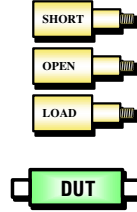

- For reflection measurements
- Need good termination for high accuracy with two-port devices
- Removes these errors:
 - Directivity
 - Source match
 - Reflection tracking

FULL 2-PORT

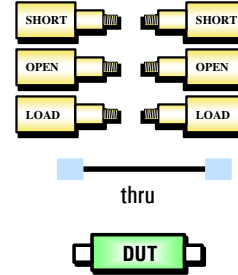

- Highest accuracy
- Removes these errors:
 - Directivity
 - Source, load match
 - Reflection tracking
 - Transmission tracking
 - Crosstalk

ENHANCED-RESPONSE

- Combines response and 1-port
- Corrects source match for transmission measurements

Network Analyzer Basics



www.agilent.com/find/backtobasics

Slide 55

A network analyzer can be used for uncorrected measurements, or with any one of a number of calibration choices, including response calibrations and one- or two-port vector calibrations. A summary of these calibrations is shown above. We will explore the measurement uncertainties associated with the various calibration types in this section.

Calibration Summary

Reflection	Test Set (cal type)	
	T/R (one-port)	S-parameter (two-port)
• Reflection tracking	✓	✓
• Directivity	✓	✓
• Source match	✓	✓
• Load match	✗	✓

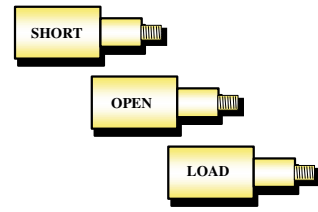

error can be corrected
error cannot be corrected
 * *enhanced response cal* corrects for source match during transmission measurements

Transmission	Test Set (cal type)	
	T/R (response, isolation)	S-parameter (two-port)
• Transmission Tracking	✓	✓
• Crosstalk	✓	✓
• Source match	(✓*)	✗
• Load match	✗	✓

Network Analyzer Basics



www.agilent.com/find/backtobasics

Slide 56

This summary shows which error terms are accounted for when using analyzers with T/R test sets (models ending with ET) and S-parameter test sets (models ending with ES). Notice that load match is the key error term that cannot be removed with a T/R-based network analyzer.

The following examples show how measurement uncertainty can be estimated when measuring two-port devices with a T/R-based network analyzer. We will also show how 2-port error correction provides the least measurement uncertainty.

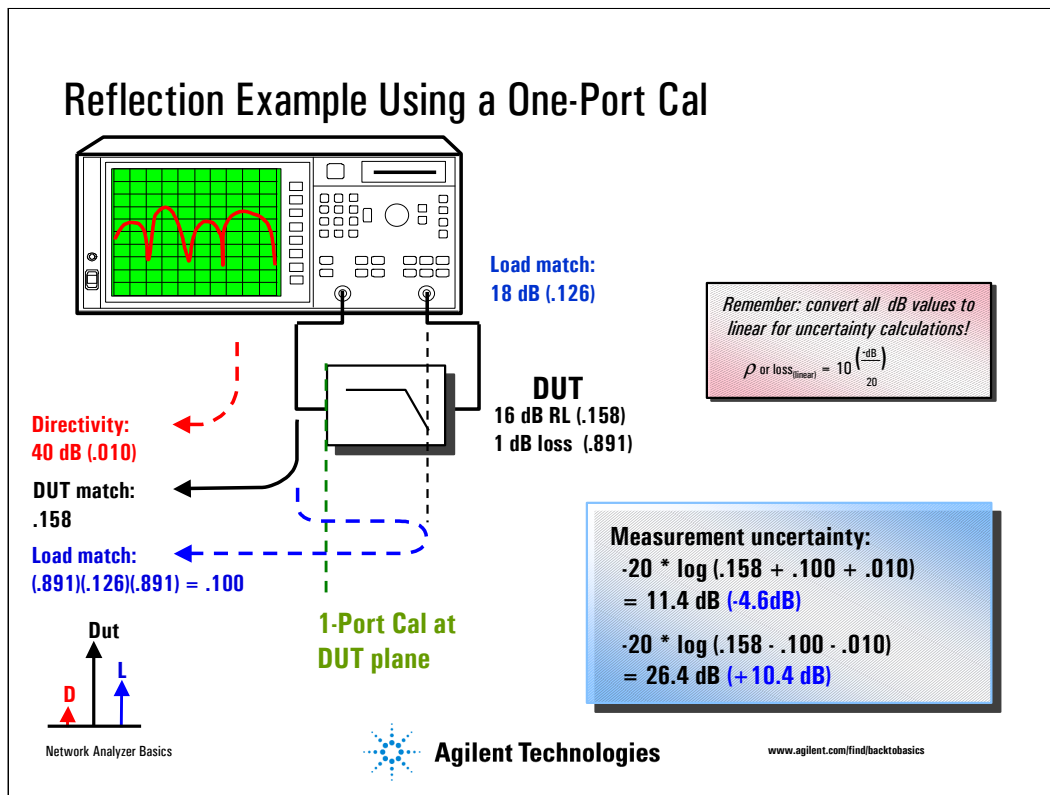

Slide 57

Here is an example of how much measurement uncertainty we might encounter when measuring the input match of a filter after a one-port calibration. In this example, our filter has a return loss of 16 dB, and 1 dB of insertion loss. Let's say the raw (uncorrected) load match of our network analyzer is specified to be 18 dB (generally, typical performance is significantly better than the specified performance). The reflection from the test port connected to the filter's output is attenuated by twice the filter loss, which is only 2 dB total in this case. This value is not adequate to sufficiently suppress the effects of this error signal, which illustrates why low-loss devices are difficult to measure accurately. To determine the measurement uncertainty of this example, it is necessary to convert all dB values into linear values. Next, we must add and subtract the undesired reflection signal resulting from the load match (with a reflection coefficient of 0.100) with the signal reflecting from the DUT (0.158). To be consistent with the next example, we will also include the effect of the directivity error signal (0.010). As a worst case analysis, we will add this signal to the error signal resulting from the load match. The combined error signal is then $0.100 + 0.010 = 0.110$. When we add and subtract this error signal from the desired 0.158, we see the measured return loss of the 16-dB filter may appear to be anywhere from 11.4 dB to 26.4 dB, allowing too much margin for error. In production testing, these errors could easily cause filters which met specification to fail, while filters that actually did not meet specification might pass. In tuning applications, filters could be mistuned as operators try to compensate for the measurement error.

When measuring an amplifier with good isolation between output and input (i.e., where the isolation is much greater than the gain), there is much less measurement uncertainty. This is because the reflection caused by the load match is severely attenuated by the product of the amplifier's isolation and gain. To improve measurement uncertainty for a filter, the output of the filter must be disconnected from the analyzer and terminated with a high-quality load, or a high-quality attenuator can be inserted between the filter and port two of the network analyzer. Both techniques improve the analyzer's effective load match.

Using a One-Port Cal + Attenuator

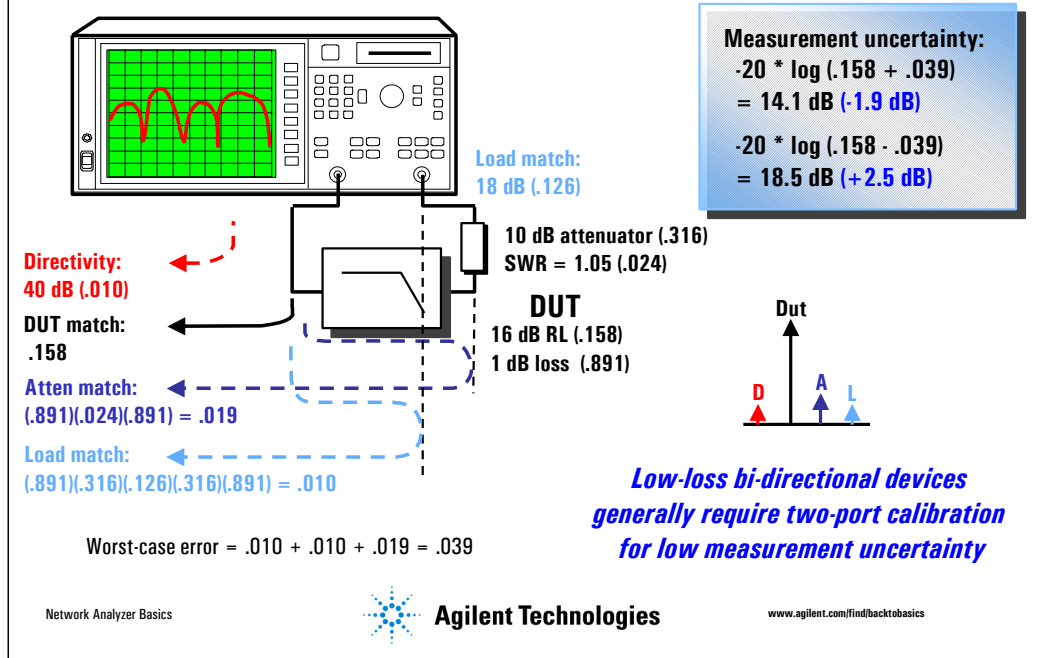

Slide 58

Let's see how much improvement we get by adding an attenuator between the output of the filter and our network analyzer. If we inserted a perfect 10 dB attenuator between port two of the network analyzer and the filter used in the previous example, we would expect the effective load match of our test system to improve by twice the value of the attenuator (since the error signal travels through the attenuator twice), which in this example, would be 20 dB. However, we must take into account the reflection introduced by the attenuator itself. For this example, we will assume the attenuator has a SWR of 1.05. Now, our effective load match is only 28.6 dB ($-20 * \log[10 \exp(-32.3/20) + 10 \exp(-38/20)]$), which is only about a 10 dB improvement. This value is the combination of a 32.3 dB match from the attenuator (SWR = 1.05) and the 38 dB effective match of the network analyzer with the 10 dB attenuator. Our worst-case uncertainty is now reduced to +2.5 dB, -1.9 dB, instead of the +10.4 dB, -4.6 dB we had without the 10 dB attenuator. While not as good as what could be achieved with two-port calibration, this level of accuracy may be sufficient for manufacturing applications. To minimize measurement uncertainty, it is important to use the best quality (lowest reflection) attenuators that your budget will allow.

Transmission Example Using Response Cal

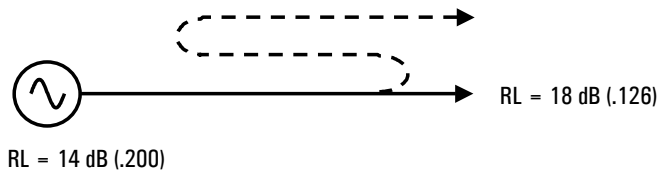

Thru calibration (normalization) builds error into measurement due to source and load match interaction

Calibration Uncertainty

$$\begin{aligned} &= (1 \pm \rho_s \rho_L) \\ &= (1 \pm (.200)(.126)) \\ &= \pm 0.22 \text{ dB} \end{aligned}$$

Mismatch error
due to source and
load matches
during calibration

Network Analyzer Basics

 Agilent Technologies

www.agilent.com/find/backtobasics

Slide 59

Let's do an example transmission measurement using only response calibration. Response calibrations offer simplicity, but with some compromise in measurement accuracy. In making a filter transmission measurement using only response calibration, the first step is to make a through connection between the two test port cables (with no DUT in place). For this example, some typical test port specifications will be used. The ripple caused by this amount of mismatch is calculated as ± 0.22 dB, and is now present in the reference data. Since we don't know the relative phase of this error signal once it passes through the DUT, it must be added to the uncertainty when the DUT is measured (see next slide) in order to compute the worst-case overall measurement uncertainty.

Filter Measurement with Response Cal

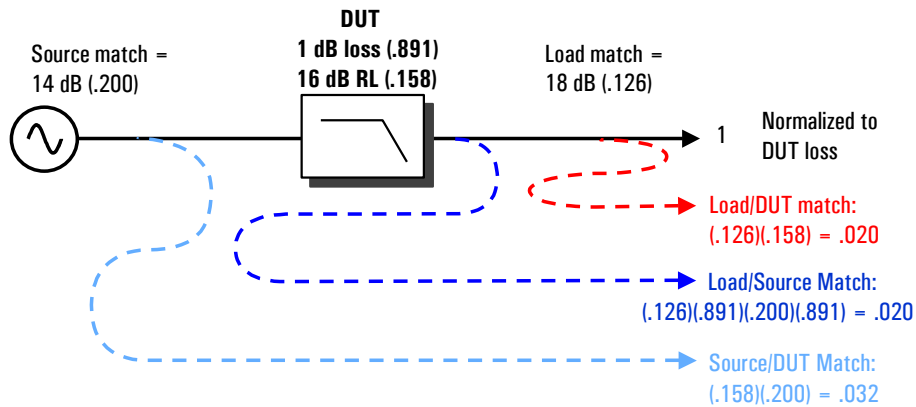

Total measurement uncertainty:

$$+0.60 + 0.22 = +0.82 \text{ dB}$$

$$-0.65 - 0.22 = -0.87 \text{ dB}$$

Measurement uncertainty

$$= 1 \pm (.020 + .020 + .032)$$

$$= 1 \pm .072$$

$$= +0.60 \text{ dB}$$

$$-0.65 \text{ dB}$$

Network Analyzer Basics



www.agilent.com/find/backtobasics

Slide 60

Now let's look at the measurement uncertainty when the DUT is inserted. We will use the same loss and mismatch specifications for the DUT and analyzer as before. We have three main error signals due to reflections between the ports of the analyzer and the DUT. Higher-order reflections are present as well, but they don't add any significant error since they are small compared to the three main terms. In this example, we will normalize the error terms to the desired signal that passes through the DUT once. The desired signal is therefore represented as 1, and error terms only show the additional transmission loss due to traveling more than once through the DUT. One of the signals passes through the DUT two extra times, so it is attenuated by twice the loss of the DUT. The worst case is when all of the reflected error signals add together in-phase ($.020 + .020 + .032 = .072$). In that case, we get a measurement uncertainty of +0.60 dB, -0.65 dB. The total measurement uncertainty, which must include the 0.22 dB of error incorporated into our calibration measurement, is about ± 0.85 dB.

Measuring Amplifiers with a Response Cal

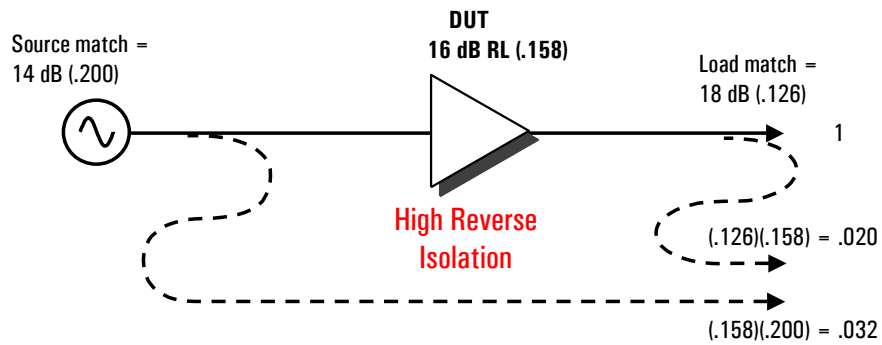

Total measurement uncertainty:
 $+0.44 + 0.22 = +0.66$ dB
 $-0.46 - 0.22 = -0.68$ dB

Measurement uncertainty
 $= 1 \pm (.020 + .032)$
 $= 1 \pm .052$
 $= +0.44$ dB
 -0.46 dB

Network Analyzer Basics

 **Agilent Technologies**

www.agilent.com/find/backtobasics

Slide 61

Now let's look at an example of measuring an amplifier that has port matches of 16 dB. The match of our test ports remains the same as our previous transmission response example. We see that the middle error term is no longer present, due to the reverse isolation of the amplifier. This fact has reduced our measurement uncertainty to about ± 0.45 dB. Our total measurement error now has been reduced to about ± 0.67 dB, versus the ± 0.85 dB we had when measuring the filter.

Filter Measurements using the *Enhanced Response* Calibration

Effective source match = 35 dB!

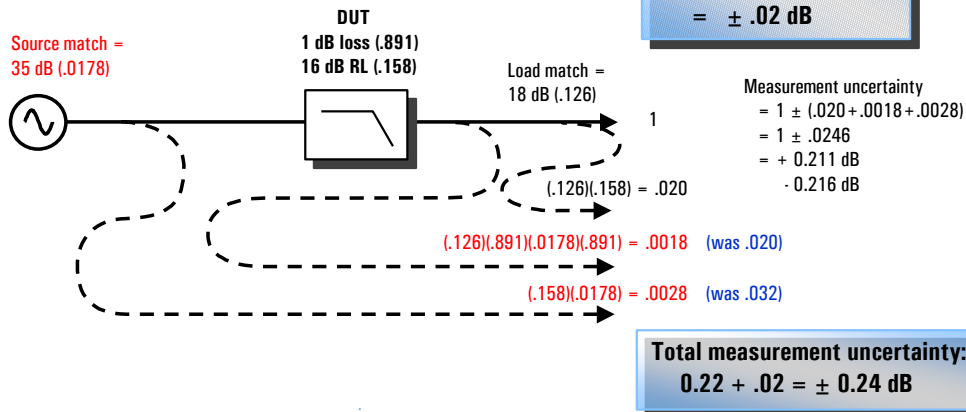

Network Analyzer Basics



www.agilent.com/find/backtobasics

Slide 62

A feature contained in many of Agilent's T/R-based network analyzers is the *enhanced* response calibration. This calibration greatly reduces all the error terms involving a reflection from the source match. It requires the measurement of short, open, load, and through standards for transmission measurements. Essentially, it combines a one-port cal and a response cal to correct source match during transmission measurements. Recall that a standard response calibration cannot correct for the source and load match error terms.

Continuing with our filter example, we see the enhanced response calibration has improved the effective source match during transmission measurements to around 35 dB, instead of the 14 dB we used previously. This greatly reduces the calibration error (± 0.02 dB instead of ± 0.22 dB), as well as the two measurement error terms that involve interaction with the effective source match. Our total measurement error is now ± 0.24 dB, instead of the previously calculated ± 0.85 dB.

Using the *Enhanced Response* Calibration Plus an Attenuator

10 dB attenuator (.316)
 SWR = 1.05 (.024 linear or 32.4 dB)
 Analyzer load match = 18 dB (.126)

$$\begin{aligned} \text{Calibration Uncertainty} &= (1 \pm \rho_S \rho_L) \\ &= (1 \pm (.0178)(.0366)) \\ &= \pm .01 \text{ dB} \end{aligned}$$

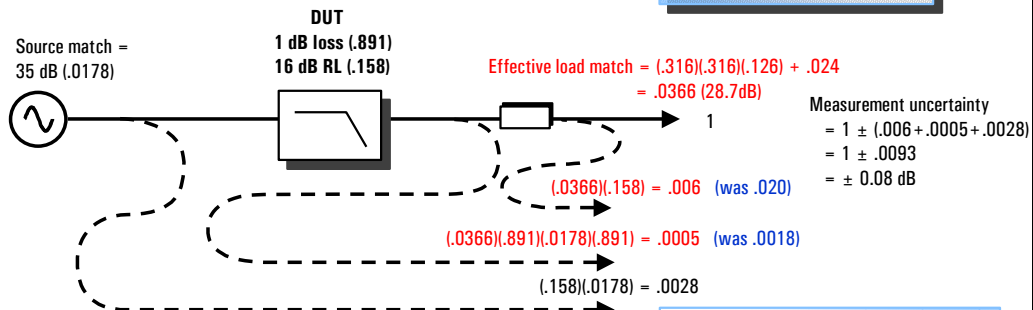

$$\begin{aligned} \text{Total measurement uncertainty:} \\ 0.01 + .08 = \pm 0.09 \text{ dB} \end{aligned}$$

Network Analyzer Basics



www.agilent.com/find/backtobasics

Slide 63

We can further improve transmission measurements by using the enhanced response calibration and by inserting a high-quality attenuator between the output port of the device and test port two of the network analyzer. In this example, we will use a 10 dB attenuator with a SWR of 1.05 (as we did with the reflection example). This makes the effective load match of the analyzer 28.7 dB, about a 10 dB improvement. Our calibration error is minuscule (± 0.01 dB), and our total measurement uncertainty has been reduced to ± 0.09 dB. This is very close to what can be achieved with two-port error correction. As we have seen, adding a high-quality attenuator to port two of a T/R network analyzer can significantly improve measurement accuracy, with only a modest loss in dynamic range.

Calculating Measurement Uncertainty After a Two-Port Calibration

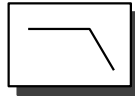

DUT
1 dB loss (.891)
16 dB RL (.158)

Corrected error terms:
(8753ES 1.3-3 GHz Type-N)

Directivity	=	47 dB
Source match	=	36 dB
Load match	=	47 dB
Refl. tracking	=	.019 dB
Trans. tracking	=	.026 dB
Isolation	=	100 dB

Reflection uncertainty

$$S_{11m} = S_{11a} \pm (E_D + S_{11a}^2 E_S + S_{21a} S_{12a} E_L + S_{11a} (1 - E_{RT}))$$

$$= 0.158 \pm (.0045 + 0.158^2 * .0158 + 0.891^2 * .0045 + 0.158 * .0022)$$

$$= 0.158 \pm .0088 = 16 \text{ dB } \mathbf{+0.53 \text{ dB}, -0.44 \text{ dB (worst-case)}}$$

Transmission uncertainty

$$S_{21m} = S_{21a} \pm S_{21a} (E_I / S_{21a} + S_{11a} E_S + S_{21a} S_{12a} E_L + S_{22a} E_L + (1 - E_{TT}))$$

$$= 0.891 \pm 0.891(10^{-6} / 0.891 + 0.158 * .0158 + 0.891^2 * .0158 * .0045 + 0.158 * .0045 + .003)$$

$$= 0.891 \pm .0056 = 1 \text{ dB } \mathbf{\pm 0.05 \text{ dB (worst-case)}}$$

Network Analyzer Basics



www.agilent.com/find/backtobasics

Slide 64

Here is an example of calculating measurement error after a two-port calibration has been done. Agilent provides values on network analyzer data sheets for effective directivity, source and load match, tracking, and isolation, usually for several different calibration kits. The errors when measuring our example filter have been greatly reduced (± 0.5 dB reflection error, ± 0.05 dB transmission error). Phase errors would be similarly small.

Note that this is a worst-case analysis, since we assume that all of the errors would add in-phase. For many narrowband measurements, the error terms will not all align with one another. A less conservative approach to calculating measurement uncertainty would be to use a root-sum-squares (RSS) method. The best technique for estimating measurement uncertainty is to use a statistical approach (which requires knowing or estimating the probability-distribution function of the error terms) and calculating the $\pm 3\sigma$ (sigma) limits.

The terms used in the equations are forward terms only and are defined as:

- E_D = directivity error
- E_S = source match
- E_L = load match
- E_{RT} = reflection tracking
- E_{TT} = transmission tracking
- E_I = crosstalk (transmission isolation)
- a = actual
- m = measured

Comparison of Measurement Examples

Reflection

Calibration type	Measurement uncertainty
One-port	-4.6/10.4 dB
One-port + attenuator	-1.9/2.5 dB
Two-port	-0.44/0.53 dB

Transmission

Calibration type	Calibration uncertainty	Measurement uncertainty	Total uncertainty
Response	± 0.22 dB	0.60/-0.65 dB	0.82/-0.87
Enhanced response	± 0.02 dB	± 0.22 dB	± 0.24
Enh. response + attenuator	± 0.01 dB	± 0.08 dB	± 0.09
Two port	-----		± 0.05

Slide 65

Here is a summary of the measurement uncertainties we have discussed so far for different types of calibration.

Response versus Two-Port Calibration

Measuring filter insertion loss

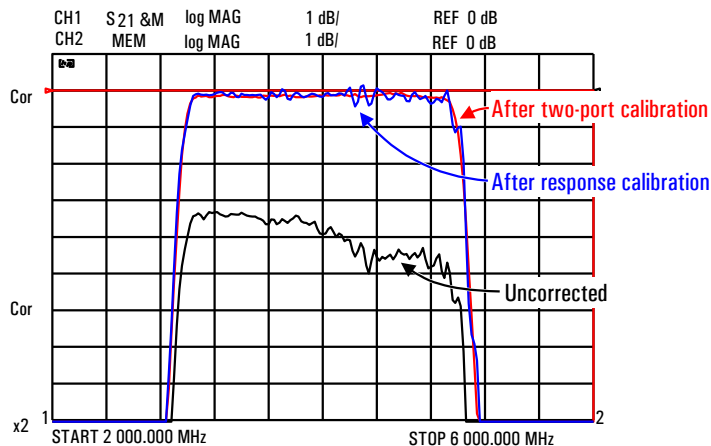

Network Analyzer Basics



www.agilent.com/find/backtobasics

Slide 66

Let's look at some actual measurements done on a bandpass filter with different levels of error correction. The uncorrected trace shows considerable loss and ripple. In fact, the passband response varies about ± 1 dB around the filter's center frequency. Is the filter really this bad? No. What we are actually measuring is the sum of the filter's response and that of our test system.

Performing a normalization prior to the measurement of the filter removes the frequency response of the system (transmission tracking error) from the measurement. The loss that was removed was most likely caused by the test cables. After normalization, the frequency response of the filter still contains ripple caused by an interaction between the system's source and load match. This ripple even goes above the 0 dB reference line, indicating gain! However, we know that a passive device cannot amplify signals. This apparent anomaly is due to mismatch error.

The measurement shown after a two-port calibration is the most accurate of the three measurements shown. Using vector-error correction, the filter's passband response shows variation of about ± 0.1 dB around its center frequency. This increased level of measurement flatness will ensure minimum amplitude distortion, increase confidence in the filter's design, and ultimately increase manufacturing yields due to lower test-failure rates.

ECal: Electronic Calibration

- Variety of modules cover 30 kHz to 67 GHz
- Eight connector types available (50 Ω and 75 Ω)
- Single-connection
 - reduces calibration time
 - makes calibrations easy to perform
 - minimizes wear on cables and standards
 - eliminates operator errors
- Highly repeatable temperature-compensated terminations provide excellent accuracy

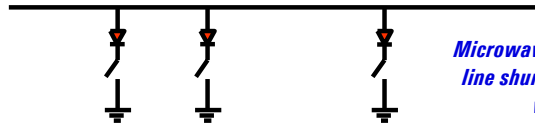

Microwave modules use a transmission line shunted by PIN-diode switches in various combinations

Network Analyzer Basics

 Agilent Technologies

www.agilent.com/find/backtobasics

Slide 67

Although the previous slides have all shown mechanical calibration standards, Agilent offers a solid-state calibration solution which makes two-port calibration fast, easy, and less prone to operator errors. A variety of calibration modules are available with different connector types and frequency ranges. The calibration modules are solid-state devices with programmable, repeatable impedance states. These states are characterized at the Agilent factory using a network analyzer calibrated with coaxial, airline-TTL standards (the best calibration available), making the ECal modules transfer standards (rather than direct standards).

For the microwave calibration modules, the various impedance states are achieved by PIN-diode switches which shunt the transmission line to ground. The number of diodes and their location vary depending upon the module's frequency range. A multitude of reflection coefficients can be generated by applying various combinations of the shunts. With no shunts, the network acts as a low loss transmission line. High isolation between the ports is obtained by driving several of the PIN shunts simultaneously. Four different states are used to compute the error terms at each frequency point. Four states are used because this gives the best trade-off between high accuracy and the time required for the calibration. With four reflection states, we have four equations but only three unknowns. To achieve the best accuracy from this over-determined set of equations, a least-squares-fit algorithm is used. Adding more impedance states at each frequency point would further improve accuracy but at the expense of more calibration time.

The RF module uses the more traditional short, open, and load terminations, and a through transmission line.

ECal modules are offered in many connector types: Type-F, Type-N, APC-7, 7-16, 3.5mm, 2.92mm, 2.4mm, and 1.85mm. RF modules include the 8509xC series and N4431A/B. In the microwave range there is the N469xA series.

For more information on ECal visit: www.agilent.com/find/ecal

ECAL User Characterization

1. Select adapters for the module to match the connector configuration of the DUT.

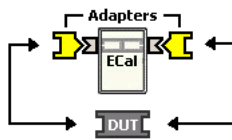

2. Perform a calibration using mechanical standards or recall a calibration.

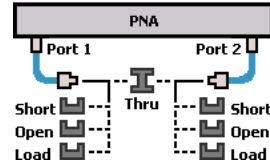

3. Measure the ECAL module, including adapters, as though it were a DUT

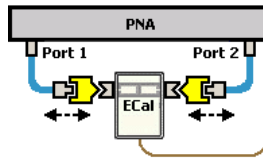

4. The measurement result is the characterization data that then gets stored inside the module.

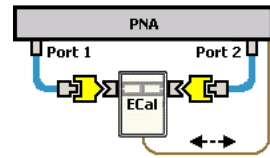

Network Analyzer Basics

 Agilent Technologies

www.agilent.com/find/backtobasics

Slide 68

A user characterized ECAL allows to add adapters to the ECAL module, re-measure the ECAL standards INCLUDING the adapters, and then add that data to ECAL memory. This extends the reference plane from the module's test ports to the adapters.

There are several reasons to perform a user characterization:

- To use adapters with ECAL module, it could be characterized with the adapters attached then subsequent ECALs are performed with a single step.
- A 4-port ECAL module could be configured with adapters of different connector types. Then a user characterization of the module could be performed. To test a DUT with a pair of the connector types on Ecal module, calibrate the VNA with a 1-step ECAL using the two connectors of the User characterized module.
- To test devices in a fixture, the characterization of the fixture could embed in the characterization of the module. To do this, during the mechanical calibration portion of the user characterization, calibrate at the reference plane of the device as it would normally be calibrated. Then the fixturing to be embedded is removed and the ECAL module to be characterized is inserted. When measuring the ECAL module, the VNA removes the effects of the fixturing and stores the measurement results in the user characterized ECAL module. Subsequent calibrations with that user characterized module will also remove the fixture effects.

Adapter Considerations

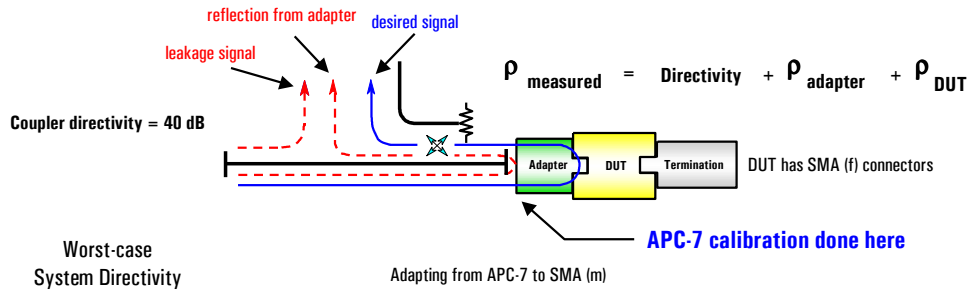

Worst-case System Directivity	Adapting from APC-7 to SMA (m)
28 dB	APC-7 to SMA (m) SWR:1.06
17 dB	APC-7 to N (f) + N (m) to SMA (m) SWR:1.05 SWR:1.25
14 dB	APC-7 to N (m) + N (f) to SMA (f) + SMA (m) to (m) SWR:1.05 SWR:1.25 SWR:1.15

Network Analyzer Basics



www.agilent.com/find/backtobasics

Slide 69

Whenever possible, reflection calibrations should be done with a cal kit that matches the connector type of the DUT. If adapters need to be used to mate the calibrated test system to the DUT, the effect of these adapters on measurement accuracy can be very large. This error is often ignored, which may or may not be acceptable. As the slide shows, the adapter causes an error signal which can add or subtract with the desired reflection signal from the DUT. Worst-case effective directivity (in dB) is now:

$$-20 \log (\text{Corrected-coupler-directivity} + \rho_{\text{adapters}})$$

If the adapter has a SWR of say 1.5 (the less-expensive variety), the effective directivity of the coupler drops to around 14 dB worst case, even if the coupler itself had infinite directivity! In other words, with a perfect Z_0 load ($\rho_L = 0$) on the output of the adapter; the reflected signal appearing at the coupled port would only be 14 dB less than the reflection from a short or open circuit. Stacking adapters compounds the problem, as is illustrated above. Consequently, it is very important to use quality adapters (or preferably, no adapters at all) in your measurement system, so system directivity is not excessively degraded. While error-correction can mitigate the effect of adapters on the test port, our system is more susceptible to drift with degraded raw (uncorrected) directivity.

Calibrating Non-Insertable Devices

When doing a through cal, normally test ports mate directly

- cables can be connected directly without an adapter
- result is a zero-length through



What is an insertable device?

- has same type of connector, but different sex on each port
- has same type of sexless connector on each port (e.g. APC-7)

What is a non-insertable device?

- one that cannot be inserted in place of a zero-length through
- has same connectors on each port (type and sex)
- has different type of connector on each port
(e.g., waveguide on one port, coaxial on the other)



What calibration choices do I have for non-insertable devices?

- use an *uncharacterized* through adapter
- use a *characterized* through adapter (modify cal-kit definition)
- swap equal adapters
- adapter removal

Slide 70

When performing a through calibration, often the test ports mate directly. For example, two cables with the appropriate connectors can be joined without a through adapter, resulting in a zero-length through path. An insertable device is one that can be substituted for a zero-length through. This device has the same connector type on each port but of the opposite sex, or the same sexless connector on each port, either of which makes connection to the test ports quite simple. A noninsertable device is one that can not be substituted for a zero-length through. It has the same type and sex connectors on each port or a different type of connector on each port, such as 7/16 at one end and SMA on the other end.

There are several calibration choices available for noninsertable devices. One choice is to use an uncharacterized through adapter. While not recommended, this might be acceptable at low frequencies where the electrical length of the adapter is relatively small. In general, it is preferable to use a characterized through adapter (where the electrical length and loss are specified), which requires modifying the calibration-kit definition. A high-quality through adapter (with good match) should be used since reflections from the adapter cannot be removed. The other two choices (swapping equal adapters and adapter removal) will be discussed next.

Swap Equal Adapters Method

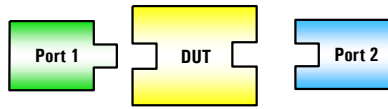

Accuracy depends on how well the adapters are matched - loss, electrical length, match and impedance should all be equal



1. Transmission cal using adapter A.



2. Reflection cal using adapter B.

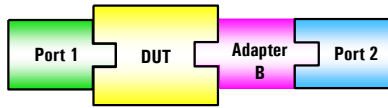

3. Measure DUT using adapter B.

Network Analyzer Basics



www.agilent.com/find/backtobasics

Slide 71

The swap-equal-adapters method is very useful for devices with the same connector type and sex (female SMA on both ends for example). It requires the use of two precision matched adapters that are equal in performance but have connectors of different sexes. For example, for measuring a device with female SMA connectors on both ends using APC-7 mm test cables, the adapters could be 7-mm-to-male-3.5-mm and 7-mm-to-female-3.5-mm. To be equal, the adapters must have the same match, characteristic impedance, insertion loss, and electrical delay. Many of Agilent's calibration kits include matched adapters for this purpose.

The first step in the swap-equal-adapters method is to perform the transmission portion of a two-port calibration with the adapter needed to make the through connection. This adapter is then removed and the second adapter is used in its place during the reflection portion of the calibration, which is performed on both test ports. This swap changes the sex of one of the test ports so that the DUT can be inserted and measured (with the second adapter still in place) after the calibration procedure is finished. The errors remaining after calibration are equal to the difference between the two adapters. The technique provides a high level of accuracy, but not as high as the more complicated adapter-removal technique.

Adapter Removal Calibration

- Calibration is very accurate and traceable
- In firmware of 8753, 8720, 8510 and PNA series
- Also accomplished with ECal modules
- Uses adapter with same connectors as DUT
- Must specify electrical length of adapter to within 1/4 wavelength of highest frequency (to avoid phase ambiguity)

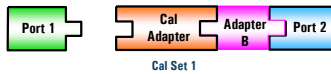

[CAL] [MORE] [MODIFY CAL SET]
[ADAPTER REMOVAL]

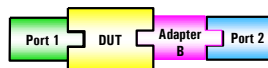

1. Perform 2-port cal with adapter on port 2. Save in cal set 1.
2. Perform 2-port cal with adapter on port 1. Save in cal set 2.
3. Use ADAPTER REMOVAL to generate new cal set.
4. Measure DUT without cal adapter.

Network Analyzer Basics



www.agilent.com/find/backtobasics

Slide 72

Adapter-removal calibration provides the most complete and accurate calibration procedure for noninsertable devices. It is available in the 8753, 8720, 8510, and PNA series of network analyzers. This method uses a through adapter that has the same connectors as the noninsertable DUT (this adapter is sometimes referred to as the calibration adapter). The electrical length of the adapter must be specified within one-quarter wavelength at each calibration frequency. Type N, 3.5-mm, and 2.4-mm calibration kits for the 8510 contain adapters specified for this purpose. For other adapters, the user can simply enter the electrical length.

Two full two-port calibrations are needed for an adapter-removal calibration. In the first calibration, the through adapter is placed on test port two, and the results are saved into a calibration set. In the second calibration, the adapter is moved to test port one and the resulting data is saved into a second calibration set. Two different calibration kits may be used during this process to accommodate devices with different connector types. To complete the adapter-removal calibration, the network analyzer uses the two sets of calibration data to generate a new set of error coefficients that completely eliminate the effects of the calibration adapter. At this point, the adapter can be removed and measurements can be made directly on the DUT.

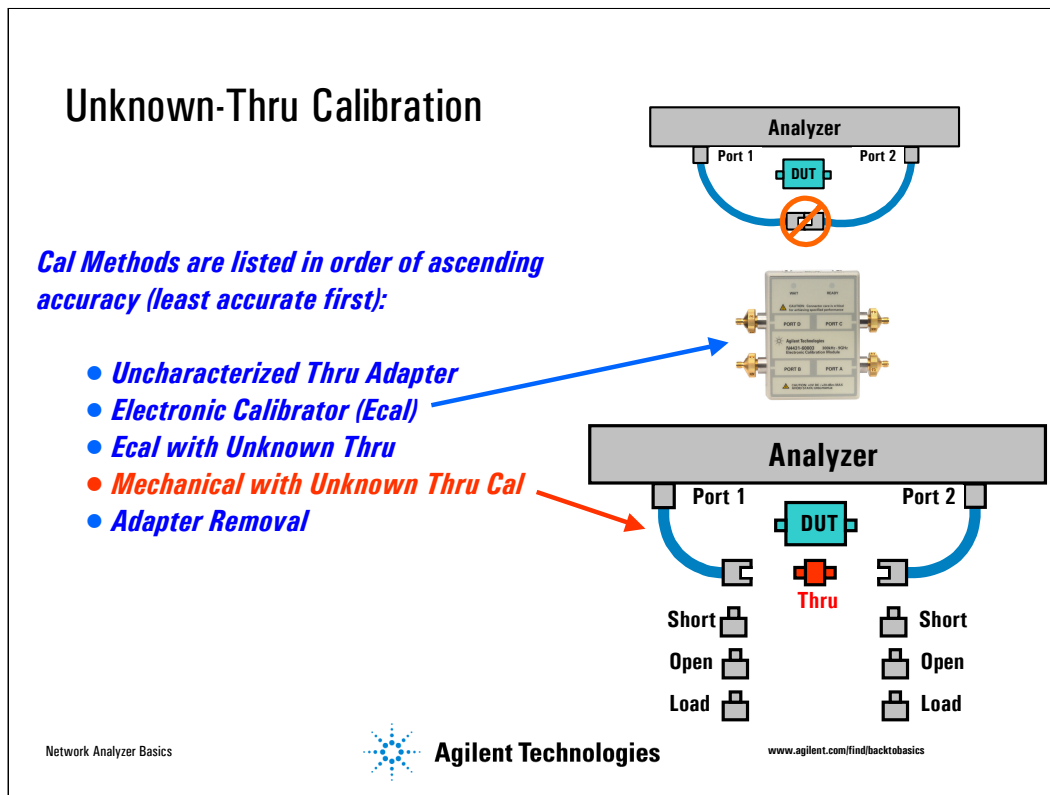

Slide 73

Unknown Thru Cal

The Unknown Thru procedure requires ONE additional step: the measurement of the thru standard. The VNA automatically reads the A, B, R1, and R2 receivers to determine the thru standard S-parameter characterization. The results are used to improve the transmission tracking error term.

After the measurement steps are completed, the VNA estimates the electrical length of the adapter. This estimate may be wrong if there are too few frequency points over the given frequency span.

The delay can be computed and changed by calculating the physical length of the adapter divided by the propagation velocity.

$$\text{Delay} = \text{Length} / \text{Propagation velocity}$$

Uncharacterized Thru Adapter

This is the easiest but least accurate method of calibrating for a non-insertable device. "Uncharacterized" means that the thru adapter's electrical delay and loss are not recorded in the analyzer. Although the adapter is used to calibrate the through path, the loss and delay are not removed from subsequent measurements because they are unknown. Using an uncharacterized thru also results in degraded transmission tracking error terms.

Adapter Removal Calibration

Adapter removal calibration provides the most accurate way to measure non-insertable devices. However, it requires additional calibration steps. Two Full 2-port calibrations are performed on each measurement port; one directly at the measurement port and one with the adapter connected to the measurement port. The result of the two sets of calibrations is a single cal set that provides Full 2-port calibration and accurate characterization and removal of the mismatch caused by the adapter.

Thru-Reflect-Line (TRL) Calibration

We know about Short-Open-Load-Thru (SOLT) calibration...

What is TRL?

- A two-port calibration technique
- Good for noncoaxial environments (waveguide, fixtures, wafer probing)
- Uses the same 12-term error model as the more common SOLT cal
- Uses practical calibration standards that are easily fabricated and characterized
- Two variations: TRL (requires 4 receivers) and TRL* (only three receivers needed)
- Other variations: Line-Reflect-Match (LRM), Thru-Reflect-Match (TRM), plus many others

*TRL was developed for **non-coaxial** microwave measurements*

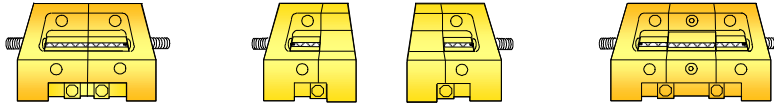

Network Analyzer Basics



Agilent Technologies

www.agilent.com/find/backtobasics

Slide 74

When performing a two-port calibration, we have some choices based on the type of calibration standards we want to use. So far, we have only discussed coaxial calibration techniques. Let's briefly look at TRL (through-reflect-line), a calibration technique that is especially useful for microwave, noncoaxial environments such as fixture, wafer probing, or waveguide. It is the second-most common type of two-port calibration, after SOLT. TRL solves for the same 12 error terms as the more common SOLT calibration, but uses a slightly different error model.

The main advantage of TRL is that the calibration standards are relatively easy to make and define at microwave frequencies. This is a big benefit since it is difficult to build good, noncoaxial, open and load standards at microwave frequencies. TRL uses a transmission line of known length and impedance as one standard. The only restriction is that the line needs to be significantly longer in electrical length than the through line, which typically is of zero length. TRL also requires a high-reflection standard (usually, a short or open) whose impedance does not have to be well characterized, but it must be electrically the same for both test ports.

For RF applications, the lengths of the transmission lines needed to cover down to low frequencies become impractical (too long). It is also difficult to make good TRL standards on printed-circuit boards, due to dielectric, line-dimension, and board-thickness variations. And, the typical TRL fixture tends to be more complicated and expensive, due to the need to accommodate throughs of two different physical lengths.

There are two variations of TRL. True TRL calibration requires a 4-receiver network analyzer. The version for three-receiver analyzers is called TRL* ("TRL-star"). Other variations of this type of calibration (that share a common error model) are Line-Reflect-Line (LRL), Line-Reflect-Match (LRM), Thru-Reflect-Match (TRM), plus many others.

Agenda

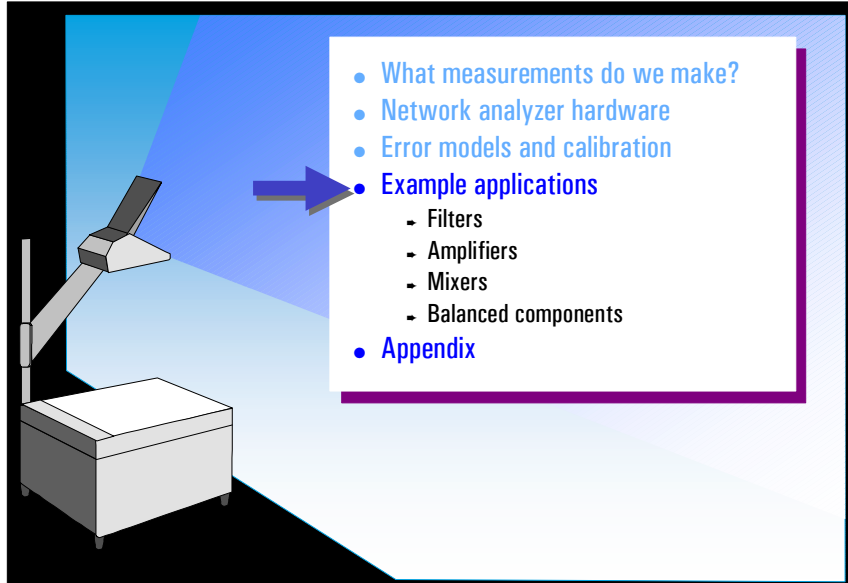

Network Analyzer Basics

 **Agilent Technologies**

www.agilent.com/find/backtobasics

Slide 75

This section will cover measurements on filters, amplifiers, mixers, and balanced components using a vector network analyzer.

Frequency Sweep - Filter Test

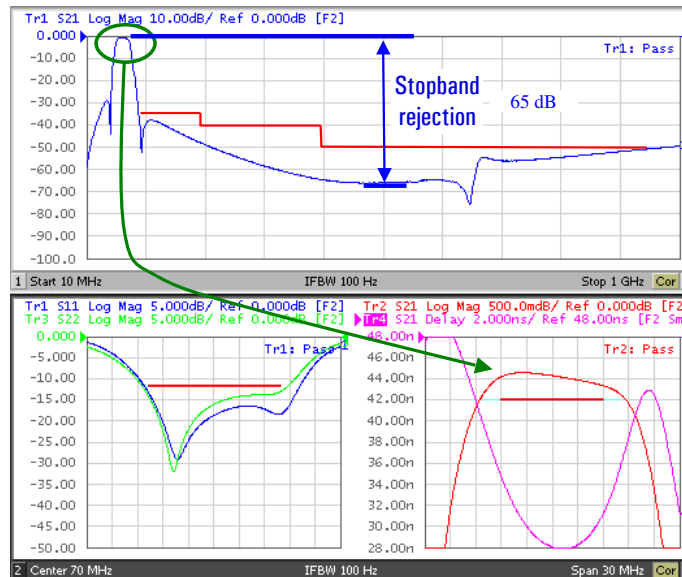

Out-of-Band
Isolation/
Rejection

Input and
Output
Return loss

Insertion loss,
flatness/ripple,
and
Group Delay

Network Analyzer Basics



Agilent Technologies

www.agilent.com/find/backtobasics

Slide 76

Shown above are the frequency responses of a filter. On the top we see the transmission response in log magnitude format, and on the bottom we see input and output return loss on the left and insertion loss and group delay on the right.

The most commonly measured filter characteristics are insertion loss and bandwidth, shown on the lower right plot with an expanded vertical scale. Another common parameter we might measure is out-of-band rejection. This is a measure of how well a filter passes signals within its bandwidth while simultaneously rejecting all other signals outside of that same bandwidth. The ability of a test system to measure out-of-band rejection is directly dependent on its system dynamic-range specification.

The return loss plot is very typical, showing high reflection (near 0 dB) in the stopbands, and reasonable match in the passband. Most passive filters work in this manner. A special class of filters exist that are absorptive in both the passband and stopband. These filters exhibit a good match over a broad frequency range.

For very narrowband devices, such as crystal filters, the network analyzer must sweep slow enough to allow the filter to respond properly. If the default sweep speed is too fast for the device, significant measurement errors can occur. This can also happen with devices that are electrically very long. The large time delay of the device can result in the receiver being tuned to frequencies that are higher than those coming out of the device, which also can cause significant measurement errors.

Optimize Filter Measurements with Swept-List Mode

Linear sweep: 718.6 ms
(201 pts, 300 Hz, -10 dBm)

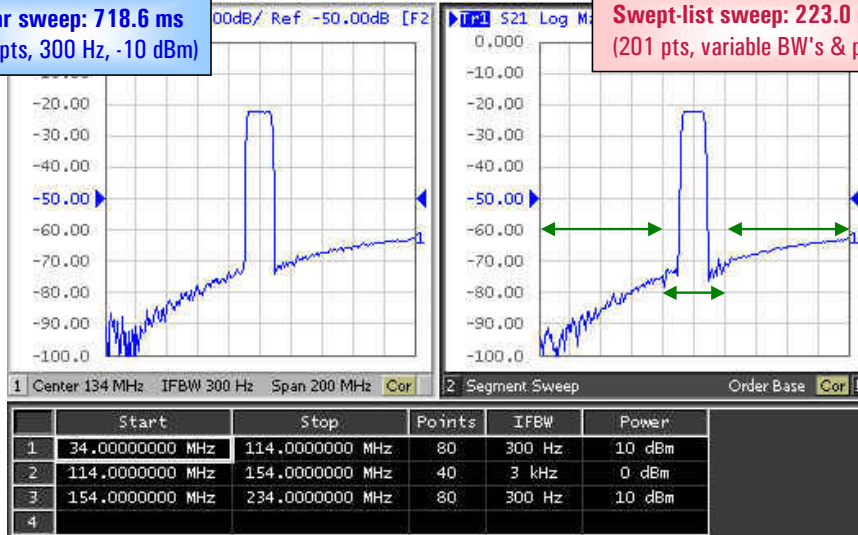

Swept-list sweep: 223.0 ms
(201 pts, variable BW's & power)

Network Analyzer Basics



Agilent Technologies

www.agilent.com/find/backtobasics

Slide 77

Many network analyzers have the ability to define a sweep consisting of several individual segments (called swept-list mode in the 8753 and 8720 series, and segment sweep in the ENA and PNA Series). These segments can have their own stop and start frequency, number of data points, IF bandwidth, and power level. Using a segmented sweep, the sweep can be optimized for speed and dynamic range. Data resolution can be made high where needed (more data points) and low where not needed (less data points); frequency ranges can be skipped where data is not needed at all; the IF bandwidth can be large when high dynamic range is not necessary (in filter passbands, for example), which decreases the sweep time, and small when high dynamic range is required (in filter stopbands, for example); the power level can be decreased in the passband and increased in the stopband for DUTs that contain a filter followed by an amplifier (for example, a cellular-telephone base-station receive filter/LNA combination). The slide shows an example of a filter/amplifier combination where the sweep time and dynamic range using a segmented sweep are considerably better compared to using a linear sweep, where the IF bandwidth and power level are fixed.

Common Amplifier Measurements

Linear measurements

Gain, gain flatness
Deviation from linear phase
Group delay

Non-linear measurements

Compression, AM/PM ; AM/AM
conversion, Harmonic distortion,
Intermodulation distortion (TOI)

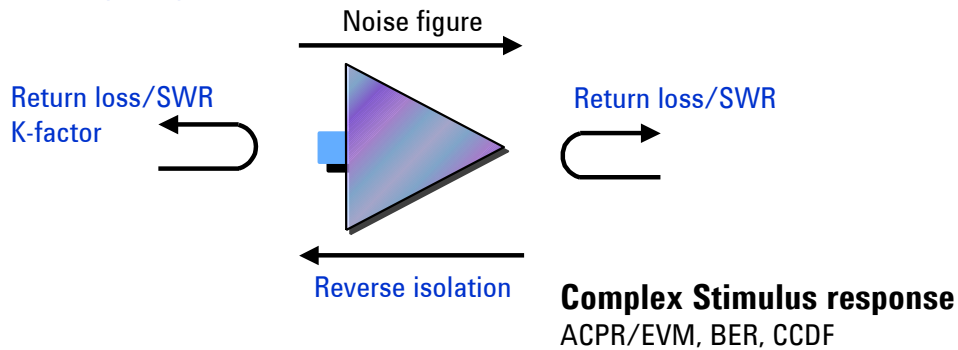

Network Analyzer Basics

 **Agilent Technologies**

www.agilent.com/find/backtobasics

Slide 78

Amplifiers are active, two-port devices which exhibit both linear and nonlinear behavior. Common linear measurements that are performed with a vector network analyzer include;

- input and output return loss (or impedance and VSWR)
- gain and gain flatness
- insertion phase
- deviation from linear phase
- group delay
- reverse isolation

Several nonlinear measurements need a more complex stimulus than a simple CW frequency or power sweep. Common examples are a broadband noise source or multiple CW signals. These measurements include harmonic and intermodulation distortion, and noise figure. Distortion measurements are particularly important since digital communication systems use narrower channel spacing and more channels than in the past, and therefore require better distortion performance than needed for simpler analog systems. Nonlinear measurements that can be performed with a vector network analyzer include;

- compression
- Amplitude Modulation to Phase Modulation conversion (AM/PM)
- Amplitude Modulation to Amplitude Modulation conversion (AM/AM)
- harmonic distortion
- intermodulation distortion or Third Order Intercept (TOI)

Other measurements require complex stimulus and response. These include adjacent channel power ratio (ACPR), error vector magnitude (EVM), complementary cumulative distribution function (CCDF), and bit error ratio (BER).

Amplifier – Linear Measurements

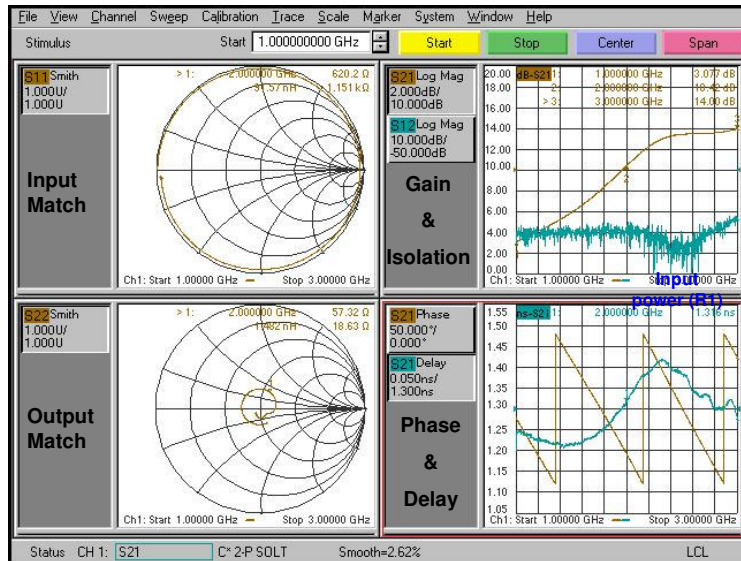
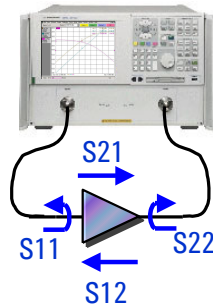

Network Analyzer Basics



www.agilent.com/find/backtobasics

Slide 79

As shown above are some of the linear characteristics of an amplifier. These include the input and output match, gain, reverse isolation, phase, and group delay. All these parameters are derived from the measured S-parameters S11, S21, S12, and S22.

Further information is found in application note AN1408-7 Amplifier Linear and Gain Compression Measurements.

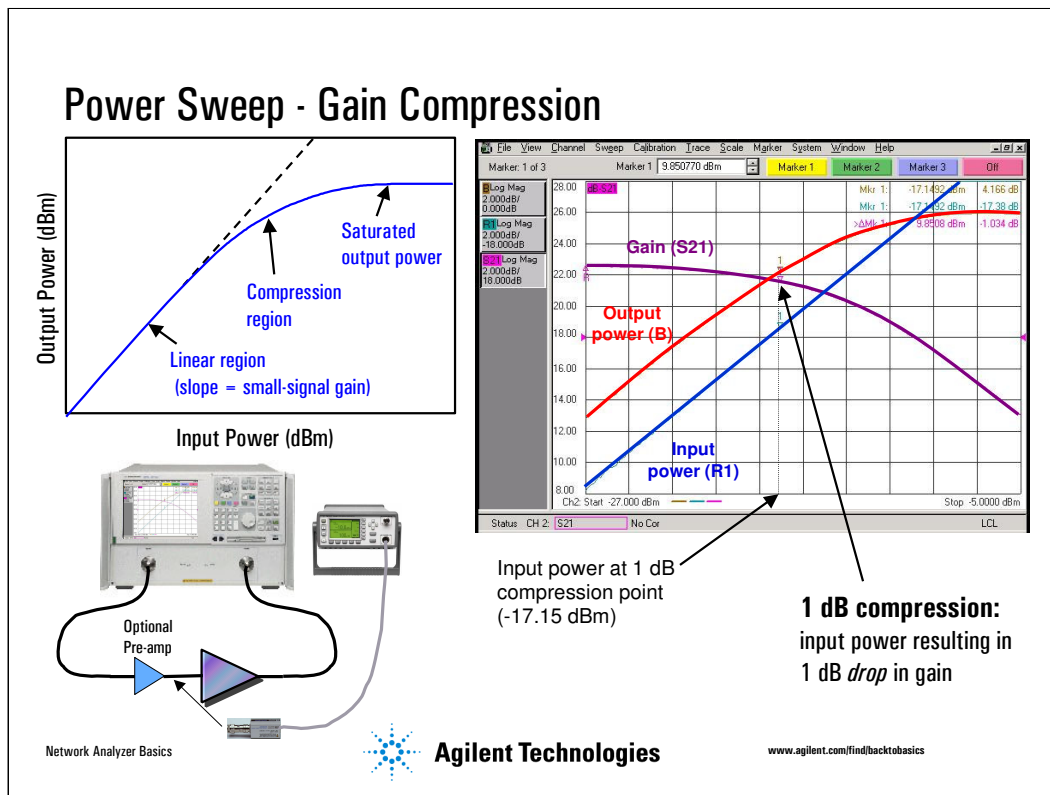

Slide 80

Many network analyzers have the ability to do power sweeps as well as frequency sweeps. Power sweeps help characterize the nonlinear performance of an amplifier. Shown above is a plot of an amplifier's output power versus input power at a single frequency. Amplifier gain at any particular power level is the slope of this curve. Notice that the amplifier has a linear region of operation where gain is constant and independent of power level. The gain in this region is commonly referred to as "small-signal gain". At some point as the input power is increased, the amplifier gain appears to decrease, and the amplifier is said to be in compression. Under this nonlinear condition, the amplifier output is no longer sinusoidal -- some of the output power is present in harmonics, rather than occurring only at the fundamental frequency. As input power is increased even more, the amplifier becomes saturated, and output power remains constant. At this point, the amplifier gain is essentially zero, since further increases in input power result in no change in output power. In some cases (such as with TWT amplifiers), output power actually decreases with further increases in input power after saturation, which means the amplifier has negative gain.

In order to measure the saturated output power of an amplifier, the network analyzer must be able to provide a power sweep with sufficient output power to drive the amplifier from its linear region into saturation. A preamp at the input of the amplifier under test may be necessary to achieve this.

The most common measurement of amplifier compression is the 1-dB-compression point, defined here as the input power* which results in a 1-dB decrease in amplifier gain (referenced to the amplifier's small-signal gain). The easiest way to measure the 1-dB-compression point is to directly display normalized gain (S21 or B/R) from a power sweep. The flat part of the trace is the linear, small-signal region, and the curved part on the right side corresponds to compression caused by higher input power. As shown above, the 1-dB compression point of the amplifier-under-test is -17.15 dBm, at the given CW frequency.

* The 1-dB-compression point is sometimes defined as the *output* power resulting in a 1-dB decrease in amplifier gain (as opposed to the *input* power).

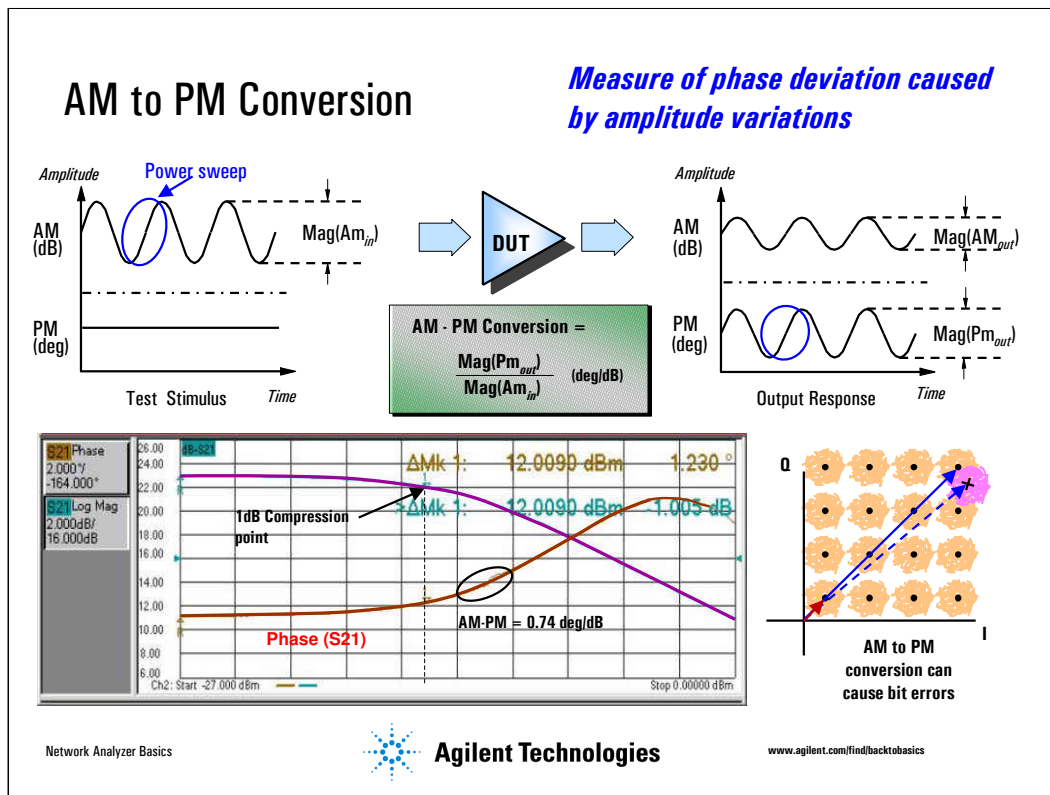

Slide 81

Another common measurement which helps characterize the nonlinear behavior of amplifiers is AM-to-PM conversion, which is a measure of the amount of undesired phase deviation (the PM) which is induced by amplitude variations inherent in the system (the AM). In a communications system, this unwanted PM is caused by unintentional amplitude variations such as power supply ripple, thermal drift, or multipath fading, or by intentional amplitude change that is a result of the type of modulation used, such as the case with QAM or burst modulation.

AM-to-PM conversion is a particularly critical parameter in systems where phase (angular) modulation is employed, because undesired phase distortion causes analog signal degradation, or increased bit-error rates (BER) in digital systems. Examples of common modulation types that use phase modulation are FM, QPSK, and 16QAM. While it is easy to measure the BER of a digital communication system, this measurement alone does not provide any insight into the underlying phenomena which cause bit errors. AM-to-PM conversion is one of the fundamental contributors to BER, and therefore it is important to quantify this parameter in communication systems.

The I/Q diagram shown above shows how AM-to-PM conversion can cause bit errors. Let's say the desirable state change is from the small solid vector to the large solid vector. With AM-PM conversion, the large vector may actually end up as shown with the dotted line. This is due to phase shift that results from a change in power level. For a 64QAM signal as shown (only one quadrant is drawn), we see that the noise circles that surround each state would actually overlap, which means that statistically, some bit errors would occur.

AM-to-PM conversion is usually defined as the change in output phase for a 1-dB increment in the input power to an amplifier, expressed in degrees-per-dB ($^{\circ}/\text{dB}$). An ideal amplifier would have no interaction between its phase response and the level of the input signal.

AM-PM conversion can be measured by performing a power sweep with a vector network analyzer, using the same transmission setup that we used for gain compression. The displayed data is formatted as the phase of S21 (transmission) versus power. AM-PM conversion can be computed by choosing a small amplitude increment (typically 1 dB) centered at a particular RF power level, and noting the resultant change in phase. The easiest way to read out the amplitude and phase deltas is to use trace markers. Dividing the phase change by the amplitude change yields AM-PM conversion.

Swept Harmonic Distortion

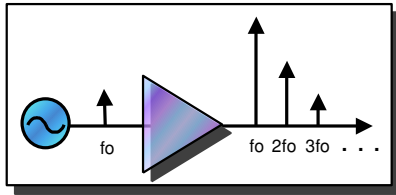

Frequency-Offset Mode (FOM)

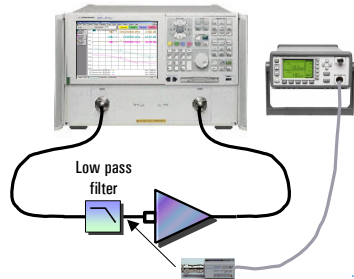

Network Analyzer Basics



Agilent Technologies

www.agilent.com/find/backtobasics

Second harmonic: 2fo

Third harmonic: 3fo

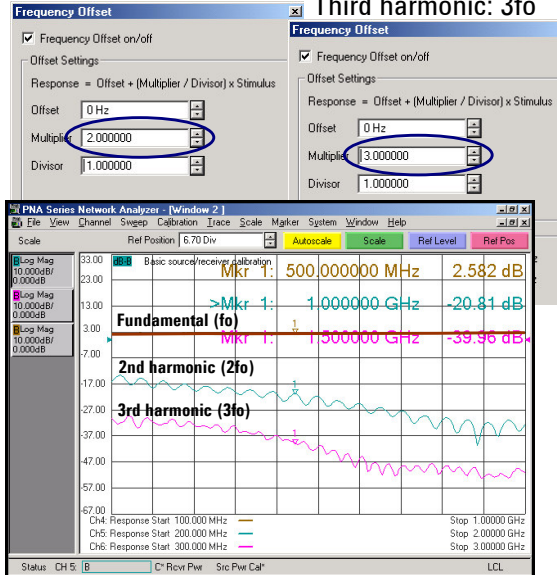

Slide 82

Traditionally, harmonic measurements are made with a spectrum analyzer at several continuous wave (CW) frequencies. Many frequencies must be tested for complete characterization, which can dramatically increase test time. With a vector network analyzer that has frequency-offset mode capability, you can make swept frequency harmonic measurements. The network analyzer source is set to the input frequency, while the receivers are tuned to the desired harmonic (2nd, 3rd, ...).

The network analyzer technique consists of using multiple measurement channels to measure the fundamental and desired harmonics. Channel 1 is configured to measure the fundamental (fo), channel 2 to measure the 2nd harmonic (2fo), channel 3 to measure the 3rd harmonic (3fo), ... For better measurement accuracy, a low pass filter is placed before the amplifier under test to suppress the harmonics generated by the network analyzer's internal source during the harmonic measurements.

The calibration process includes a source power cal and receiver cal for each measurement channel. A power meter and sensor is required for this step. Optionally, mismatch errors can be further corrected using a special correction technique called Scalar Mixer Calibration (SMC).

Further information is found in application note AN1408-8 Amplifier Swept-Harmonic Measurements.

The Frequency-Offset Mode (FOM) is available on the microwave PNA and PNA-L series (E836xB, E8361A, and N5230A) and RF ENA series (E5070B and E5071B) network analyzers.

Intermodulation Distortion – 2 tone

The diagram shows a network analyzer setup for measuring intermodulation distortion. Two tones, f1 and f2, are generated by separate sources, pass through low-pass filters (LPF) and isolators, and are combined in a power combiner. The combined signal then passes through an amplifier. The output is measured by the network analyzer. The screenshot shows the network analyzer's Frequency Offset Mode (FOM) interface, displaying a spectrum plot with markers for f1, f2, 2f1 - f2, and 2f2 - f1. The FOM settings are shown, including the Frequency Offset mode being on/off, and the CW Override setting.

Frequency-Offset Mode (FOM)

CW Override

Network Analyzer Basics

Agilent Technologies

www.agilent.com/find/backtobasics

Slide 83

Intermodulation distortion (IMD) is a measure of nonlinearity of an amplifier. When two or more CW frequencies are applied to an amplifier, the output contains additional frequency components called intermodulation products. For instance, when the amplifier is stimulated with 2-tone signals with frequencies f1 and f2, the output will contain signals at the following frequencies: $nf_1 + mf_2$ where $n, m = 0, \pm 1, \pm 2$, etc. The third order products, $2f_2 - f_1$ and $2f_1 - f_2$, are a major concern because of their proximity to the carriers making them difficult to filter out.

Shown above is a configuration for measuring the IMD performance of an amplifier using two tones. One tone is generated by the network analyzer's internal source and the second tone is generated using an external source such as an ESG or PSG. These two tones are combined using a power combiner. Low pass filters are necessary to remove any unwanted harmonic and spurious signals generated by the sources. Isolators are used to prevent the two sources from interfering with each other.

There are several ways the network analyzer can be configured to measure the amplifier's IMD products. One method is to use four measurement channels, one assigned to each of the IMD frequencies f1, f2, 2f2 - f1 and 2f1 - f2. This allows measurements at fixed and swept frequencies.

Another method is to use a single measurement channel to sweep the output of the amplifier while the input frequencies are fixed. This is accomplished using the CW Override capability within the Frequency Offset Mode function.

The amplifier's Third Order Intercept (TOI or IP3) point can be calculated from;

$$IP3 \text{ (dBm)} = P(f_1) + \frac{1}{2} [P(f_1) - \max \{ P(2f_2 - f_1), P(2f_1 - f_2) \}]$$

In the above example, $IP3 \text{ (dBm)} = -1.193 + \frac{1}{2} [-1.193 - (-41.30)] = +18.86 \text{ dBm}$

Further information is found in application note AN1408-9 Amplifier Intermodulation-Distortion Measurements.

Mixer Component Measuring Conversion Loss

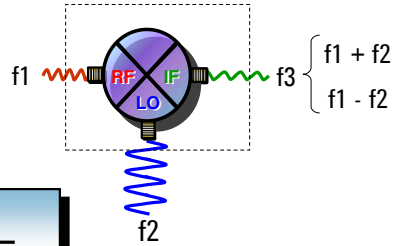

$$\text{Conversion loss}_{\text{dB}} = 10 \log \frac{\text{mag}(f_{\text{in}})_{\text{mW}}}{\text{mag}(f_{\text{out}})_{\text{mW}}}$$

Function of LO power

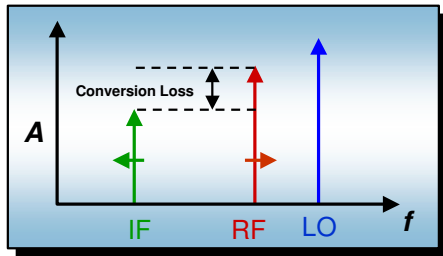

Swept IF

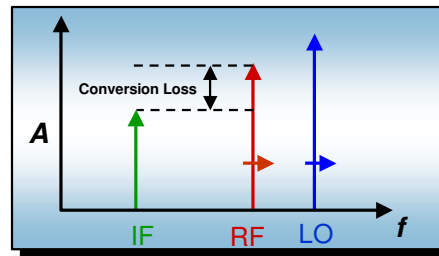

Fixed IF

Network Analyzer Basics



Agilent Technologies

www.agilent.com/find/backtobasics

Slide 84

The first mixer measurement we will cover is conversion loss. In the case of a module with integrated amplifier we will see a conversion gain. Conversion loss is defined as the ratio of CW input power to the CW output response power expressed in dB, for a given amount of applied local oscillator power, and it is usually measured versus frequency. While conversion loss of a mixer is usually very flat within the frequency span of its intended operation, the average loss will vary with the level of the LO.

The easiest type of conversion loss or gain flatness measurement is to sweep the RF input and keep the LO frequency constant. This is called a swept IF measurement. This measures the conversion loss over the full operating range of the mixer and not just at the center of its bandwidth. It can be said to operate with a certain performance over the whole band. Notice when the LO is above the RF, known as high side mixing, the IF will sweep in the opposite direction from the RF.

If the frequency translating device has an integrated IF filter, it might be tested by holding the IF fixed and having the LO track the RF signal. In order to accomplish this, the LO must sweep in conjunction with the RF input signal. In many cases, this measurement more closely matches the operation of the DUT in the actual application.

Scalar Mixer Calibration Measurement Setup

- No reference mixer needed
- No output filter needed
- Highest accuracy conversion-loss measurements with simple setup and cal
- Removes mismatch errors during calibration and measurements by combining 2-port and power-meter calibrations

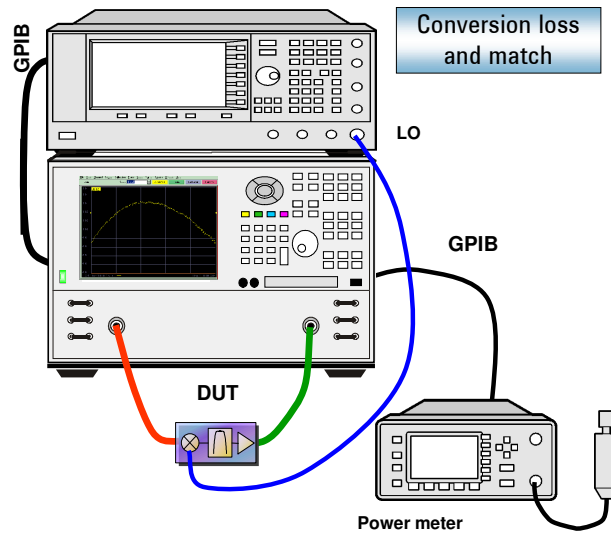

Network Analyzer Basics

 Agilent Technologies

www.agilent.com/find/backtobasics

Slide 85

The Scalar Mixer Calibration (SMC) provides highest Scalar (amplitude only) accuracy for measurements of conversion loss/gain.

The SMC method eliminates mismatch errors during calibration and measurements by combining 2-port and power-meter calibrations. It is a two-step process: first, we perform two 2-port calibrations: one over the INPUT frequencies and one over the OUTPUT frequencies of the DUT. The second step performs a match-corrected power-meter calibration. A match-corrected power-meter calibration differs from a traditional power-meter calibration in that the match of the power sensor is measured and is used to calculate the true incident power. The calculated mismatch between the power-sensor match and the corrected-source match of the VNA is used to correct the raw power values read by the sensor.

Further information is found in application notes;

AN1408-1 Mixer Transmission Measurements Using the Frequency Converter Application

AN1408-2 Mixer Conversion Loss and Group Delay Measurement Techniques and Comparisons

AN1408-3 Measurement and Calibration Accuracy Using the Frequency Converter Application

AN1463-6 Accurate Mixer Measurements Using the Frequency-Offset Mode

AN1463-7 Accurate Mixer Conversion Loss Measurement Techniques

Mixer Component Conversion Phase

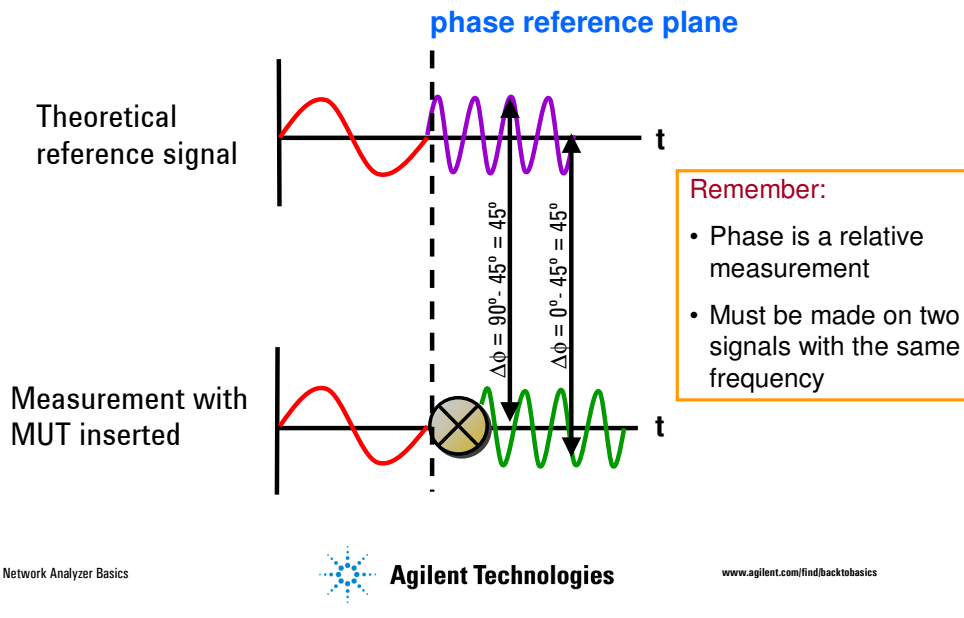

Slide 86

It is also of interest what the phase is doing as it passes through the mixer. Since the input and output frequencies are not the same, the definition of conversion phase can be confusing. We define the conversion phase as the phase shift of the output compared to the input when the input synchronously converts to the output frequency with an ideal, zero phase shift.

Remember, the definition of conversion loss was the input power level compared to the output power level, but was a function of the LO as well. Likewise, the phase of the output signal is a function of the input phase and the LO phase. Therefore, the reference signal must be converted in frequency with a constant phase relationship to the signal it will be compared to. This is referred to as synchronous conversion. Any different frequency shift between the two signals will cause a phase measurement error. This is the primary challenge when measuring converters with internal LO that their phase can not be referenced to.

In this example the input (red) signal can not be compared directly to the output (green) signal. Only after the output reference (purple) is created can the desired output signal phase be measured. Once the reference is created it can be used as a reference regardless of where the signal is compared. Its phase shift or difference will remain the same. Notice that at sample point B and C both return the same phase shift of 135 degrees independent of the point chosen to make the comparison.

Vector Mixer Calibration Technique

- Most accurate measurements of phase and absolute group delay
- Removes magnitude and phase errors for transmission and reflection measurements by calibrating with characterized through mixer

Three step calibration:

- **Step 1:** measure “normal” error terms at input and output frequencies
- **Step 2:** completely characterize a calibration mixer/filter pair using reflection measurements (acquire S11, S22, and “C21”)
- **Step 3:** calibrate transmission tracking term of test system using characterized mixer/filter as a through standard

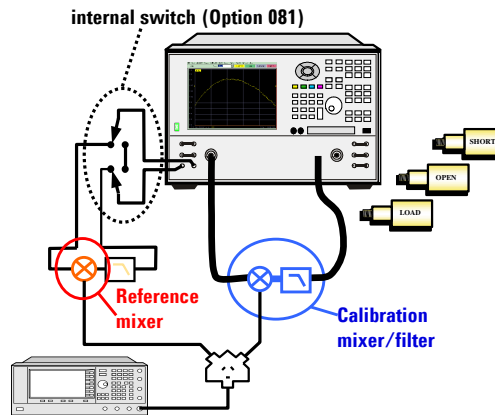
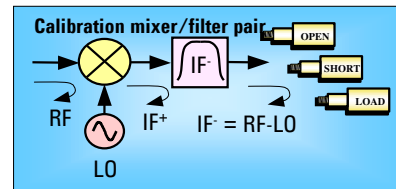

Network Analyzer Basics

 Agilent Technologies

www.agilent.com/find/backtobasics

Slide 87

The Vector Mixer Calibration (VMC) provides unparalleled accuracy for measurements of relative phase and absolute group delay but requires a more complicated setup and calibration procedure than Scalar Mixer Calibration.

The VMC is a new method that eliminates most of the sources of errors of previous methods. It is a two-step process: first, we characterize a mixer/filter combination, which becomes the “calibration mixer”. Next, we use the calibration mixer (and image filter) to calibrate a more general purpose VNA-based test system. After the calibration, both reciprocal and non-reciprocal mixers and converters can easily be measured.

Further information is found in application notes;

AN1408-1 Mixer Transmission Measurements using the Frequency Converter Application

AN1408-2 Mixer Conversion Loss and Group Delay Measurement Techniques and Comparisons

AN1408-3 Measurement and Calibration Accuracy using the Frequency Converter Application

AN1463-6 Accurate Mixer Measurements Using the Frequency-Offset Mode

AN1463-7 Accurate Mixer Conversion Loss Measurement Techniques

Methods Comparison

Scalar Mixer Calibration Match corrected cal vs Un-corrected

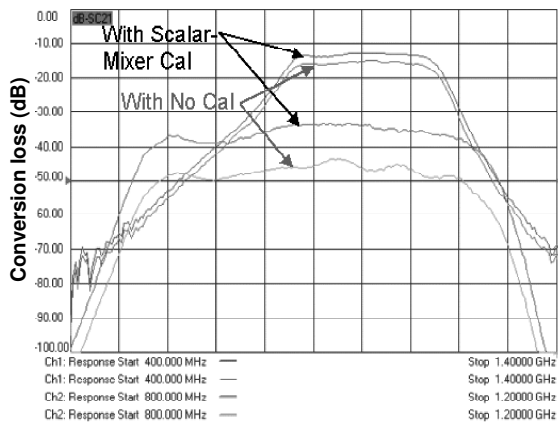

Vector Mixer Calibration Characterization mixer vs. same mixer with 15 cm airline at input (difference):

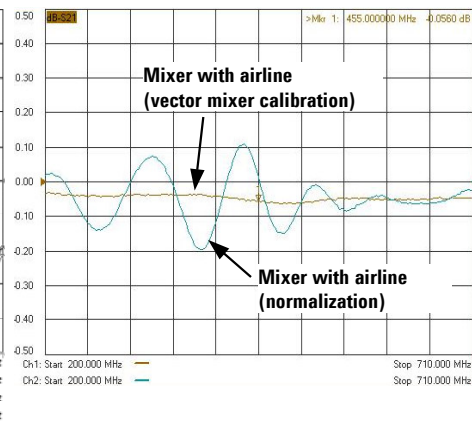

Network Analyzer Basics



www.agilent.com/find/backtobasics

Slide 88

The Scalar Mixer Calibration figure on the left shows two measurements made on a two-stage down converter that includes filters and isolations with RF input power of .20 dBm. The RF input sweeps from 9.4 - 10.4 GHz and down converted to a first IF of 3.4 - 4.4 GHz. With a second LO of 3 GHz the signal is down converted again to 400 - 1.4 GHz, both sweeps use 2001 measurement points and an IF bandwidth of 1000 Hz. Two Agilent PSG signal generators were used as the LOs with + 10 dBm input to the mixer. The figure shows 4 traces. One pair shows the full 1 GHz bandwidth, which includes the reject band of the input filter, and the other pair narrows the span to only the passband and increases the scale to 2 dB per division. This displays more clearly the 0.5 dB of error ripple that is present in the upper passband of the uncorrected measurement. In addition to removing the 2 dB cable loss effects from the measurement, the scalar-mixer calibration also removes these error signals from affecting measurement accuracy.

The Vector Mixer Calibration error correction can be evaluated by measuring the same mixer, first by itself, and next with an airline (a device with low-loss, good match, but with delay). Ideally, the test system should show the conversion loss of the mixer reduced by exactly the loss of the airline. However, mismatch effects can cause extra ripple on the measurements. The right figure shows the result of measuring the mixer first without the airline, normalizing the trace, then again with the airline (darkest trace). Also shown is the same measurement but with a scalar calibration. The airline loss is nearly a flat line, as measured on a VNA in normal mode. Clearly, there is more than substantial improvement in the error of the measurement, as represented by the ripple.

Balanced Devices, why are they used?

- **Wireless Communications**

- Balanced topology less susceptible to EMI, noise
- Less shielding required
- RF grounding less critical
- Better RF performance, smaller, lighter phones
- LVDS extends battery life



- **Signal Integrity**

- Verify waveform quality of high speed digital signals
- Engineers primarily interested in time-domain analysis

Network Analyzer Basics



Agilent Technologies

www.agilent.com/find/backtobasics

Slide 89

Let's take a look at the target applications that require balanced measurements on differential circuits or devices. The first application is for mobile wireless appliances, such as cell phones and pagers. Using differential circuit topology in these items has several significant advantages. First of all, balanced circuits are less susceptible to electro-magnetic interference or EMI, whether from an external source like a radio station, or from digital noise from within the phone itself. This means that less shielding is required, allowing the phones to be smaller and lighter. The grounding requirements for differential circuits are also less severe, which improves the RF performance of the phone. Using low-voltage differential signals can also extend battery life.

The second market is a subset of data communications called signal integrity. Signal integrity engineers must verify the time-domain waveforms of high-speed clock and data signals, to ensure that the digital circuitry will function properly. For the most part, these engineers only use time-domain analysis, and are not familiar with frequency domain tools such as network analyzers.

What are Balanced Devices?

Ideally, respond to differential and reject common-mode signals

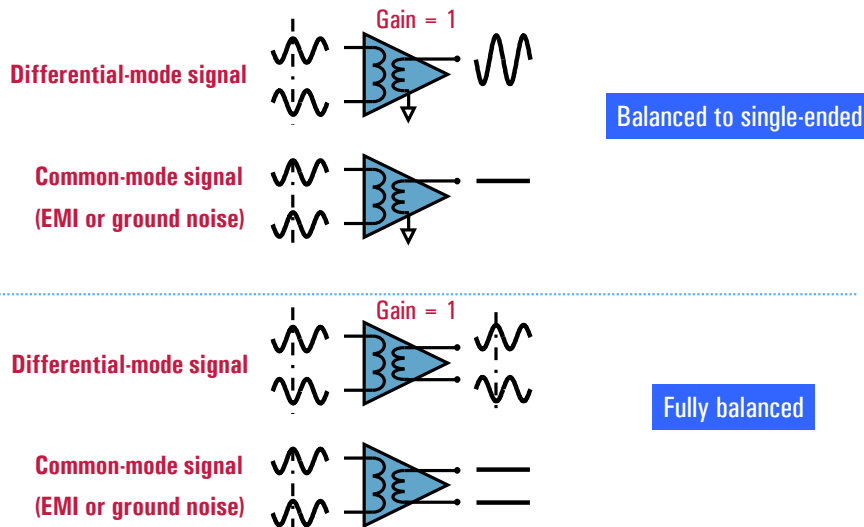

Network Analyzer Basics

Agilent Technologies

www.agilent.com/find/backtobasics

Slide 90

Let's briefly review how balanced devices work. Ideally, a balanced device only responds to or generates differential-mode signals, which are defined as two signals that are 180° out of phase with one another. These devices do not respond to or generate in-phase signals, which are called common-mode signals. In the top example of a balanced-to-single-ended amplifier, we see that the amplifier is responding to the differential input, but there is no output when common-mode or in-phase signals are present at the input of the amplifier. The lower example shows a fully balanced amplifier, which has both differential inputs and outputs. Again, the amplifier only responds to the differential input signals, and does not produce an output in response to the common-mode input.

One of the main reasons that balanced circuits are desirable is because external signals that are radiated from an RF emitter show up at the terminals of the device as common mode, and are therefore rejected by the device. These interfering signals may be from other RF circuitry or from the harmonics of digital clocks or data. Balanced circuits also reject noise on the electrical ground, since the noise appears in phase to both input terminals, making it a common-mode signal.

Real world devices don't completely reject common mode noise or generate only differential signals. A balanced device will produce a small amount of common mode signal that rides on top of the differential signal output. This common mode signal is the result of differential to common mode conversion, and it is a source of electromagnetic interference. What can happen when a common-mode signal is present at the input to the device. Common to differential mode conversion results in a differential signal at the output of the device, which will interfere with the desired differential output, which is not shown on the slide for simplicity. This mode conversion makes a circuit susceptible to electromagnetic interference.

Conventional Balanced Measurement Method using Balun Transformers

- Difficult to make accurate calibration for balun
- Balun's freq. range is not wide
- Actual Balun has imbalance

- Mixed-mode S-parameters can be defined as follows:

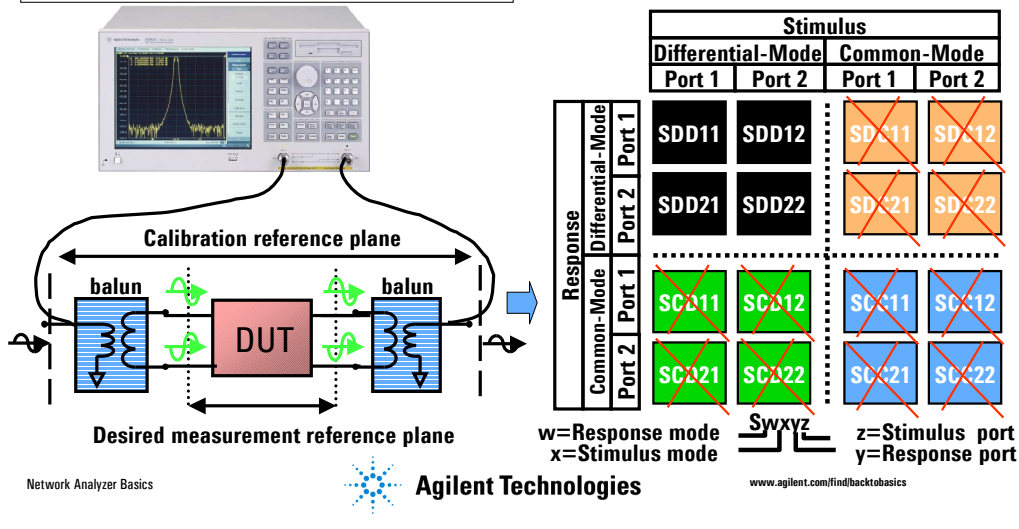

Slide 91

Traditionally, balanced devices are measured with 2-port network analyzers with physical balun transformers that convert the analyzers' single-ended test ports to the balanced ports. But there are several problems with this physical balun method.

- It is difficult to make accurate calibration for the baluns, because there is no accurate "balanced calibration kit" for making calibration at the balanced ports of the baluns. If we perform calibration at the single-ended ports of test cables by using coaxial calibration kits, the error factors caused by the baluns cannot be removed.
- It is difficult to find the baluns that can cover wide frequency ranges.
- Actual baluns do not have ideal characteristics and their imbalance affect on the measurements.

This slide shows the concept of mixed-mode S-parameters for balanced to balanced devices. The mixed-mode S-parameter matrix consists of 4 elements, differential to differential S-parameters (Sddxx), common to common S-parameters (Sccxx), differential to common S-parameters (Scdxx), and common to differential S-parameters (Sdcxx).

Mathematical Balun Method



Connect balanced DUT directly to 4-port ENA without baluns.

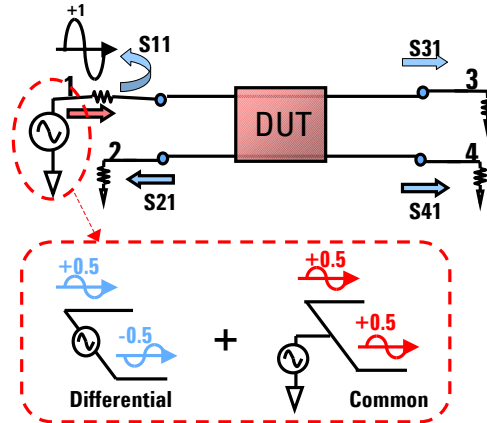

Single-ended S-parameters

$$\begin{bmatrix} S_{11} & S_{12} & S_{13} & S_{14} \\ S_{21} & S_{22} & S_{23} & S_{24} \\ S_{31} & S_{32} & S_{33} & S_{34} \\ S_{41} & S_{42} & S_{43} & S_{44} \end{bmatrix}$$

Network Analyzer Basics



www.agilent.com/find/backtobasics

Slide 92

A fixture simulator offers a new approach to measuring balanced devices without using actual balun transformers, which is called the mixed-mode S-parameter measurement method or the mathematical balun method.

The VNA measures full 4-port single-ended S-parameters by considering a balanced DUT as a 4-port device. The VNA stimulates the DUT's 1, 2, 3 and 4 ports with a single-ended test signal. Applying the single-ended signal to each port is mathematically equivalent to applying superposed differential and common mode signals to the paired ports as shown in this figure, assuming that the DUT is a linear device.

Mathematical Balun Method

Measure
Single-ended S-parameters

$$\begin{bmatrix} S_{11} & S_{12} & S_{13} & S_{14} \\ S_{21} & S_{22} & S_{23} & S_{24} \\ S_{31} & S_{32} & S_{33} & S_{34} \\ S_{41} & S_{42} & S_{43} & S_{44} \end{bmatrix}$$

Mathematically simulate Hybrid Balun
to extract differential and common

$$\begin{pmatrix} V_{diff} \\ V_{comm} \end{pmatrix} = \begin{pmatrix} A, B \\ C, D \end{pmatrix} * \begin{pmatrix} V_1 \\ V_2 \end{pmatrix}$$

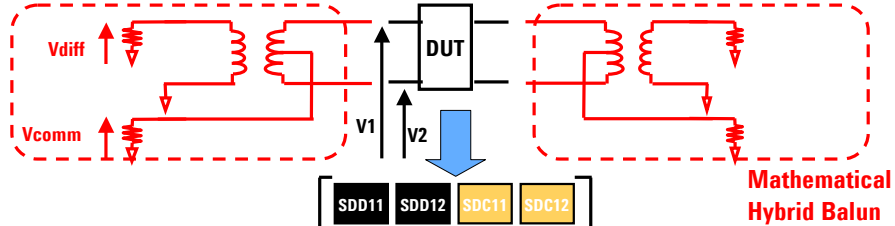

Obtain
Mixed-mode S-parameters

SDD11	SDD12	SDC11	SDC12
SDD21	SDD22	SDC21	SDC22
SCD11	SCD12	SCC11	SCC12
SCD21	SCD22	SCC21	SCC22

Network Analyzer Basics



www.agilent.com/find/backtobasics

Slide 93

The mathematical balun method decomposes single-ended measurement data into differential and common mode elements by simulating the operation of ideal hybrid baluns. This simulation provides a mixed mode S-parameter matrix, which shows the characteristics of the balanced DUT.

The mathematical balun method has the following advantages over the conventional physical balun method.

- Mathematical baluns provide ideal unbalanced-to-balanced conversion over wide frequency ranges.
- Both differential and common mode S-parameters can be measured very easily.
- The measurement system can be accurately calibrated with NIST traceable coaxial calibration kits.

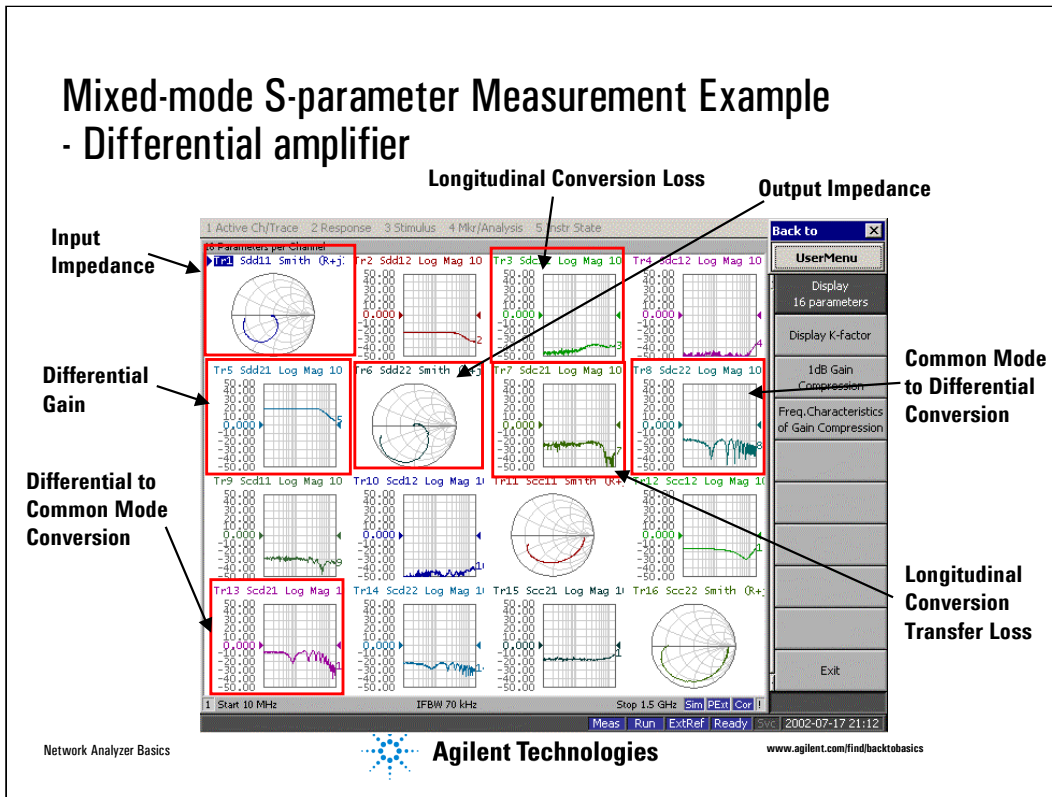

Slide 94

This slide shows a full 16 mixed-mode S-parameter measurement example of a differential amplifier by using the mathematical balun method. Again, the 4x4 single-ended S-parameters can be mathematically converted to the mixed-mode S-parameters very easily.

Sdd11 shows the differential input impedance, Sdd22 shows the differential output impedance, and Sdd21 shows the differential gain.

LCL (Longitudinal Conversion Loss) and LCTL (Longitudinal Conversion Transfer Loss) are important parameters of balanced components that are related to imbalance characteristics. It is not so easy to measure LCL and LCTL with the physical balun method. Now the mathematical balun method makes these measurements very easy. LCL and LCTL can directly be seen by setting measurement parameter to Sdc11 and Sdc21.

Further information is found in application notes;

- AN1373-2 Concepts in Balanced Device Characterization
- AN1373-5 Balanced Measurement Example: SAW Filters
- AN1373-6 Balanced Measurement Example: Baluns
- AN1373-7 Balanced Measurement Example: Differential Amplifiers

Agenda

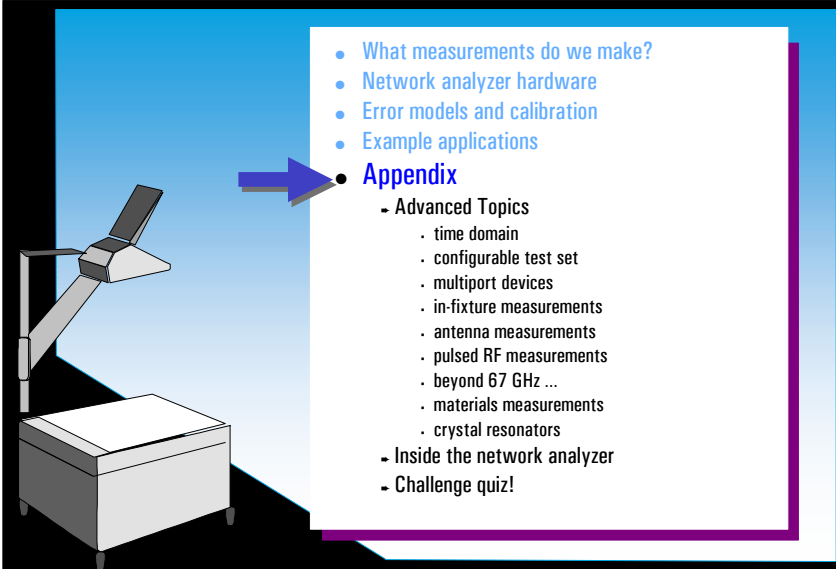

- What measurements do we make?
- Network analyzer hardware
- Error models and calibration
- Example applications
- **Appendix**
 - Advanced Topics
 - . time domain
 - . configurable test set
 - . multiport devices
 - . in-fixture measurements
 - . antenna measurements
 - . pulsed RF measurements
 - . beyond 67 GHz ...
 - . materials measurements
 - . crystal resonators
 - Inside the network analyzer
 - Challenge quiz!

Network Analyzer Basics



www.agilent.com/find/backtobasics

Slide 95

The appendix is intended to provide more detail on selected topics, such as time domain, antenna measurements, and pulsed RF measurements. These are included here as reference material.

Time-Domain Reflectometry (TDR)

- What is TDR?
 - time-domain reflectometry
 - analyze impedance versus time or distance
 - distinguish between inductive and capacitive transitions
- With gating:
 - analyze transitions
 - analyze standards

Applications:

- fixture design
- in-fixture calibration standards
- trouble-shooting
- fault location

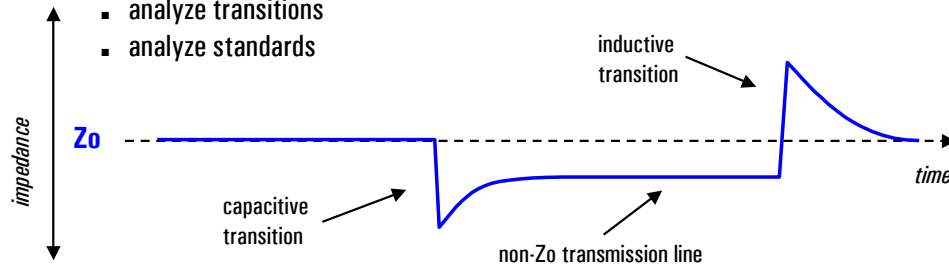

Network Analyzer Basics



www.agilent.com/find/backtobasics

Slide 96

Time-domain reflectometry (TDR) is a very useful tool that allows us to measure impedance versus distance. One good application for TDR is fixture design and the design of corresponding in-fixture calibration standards. We can distinguish between capacitive and inductive transitions, and see non- Z_0 transmission lines. TDR can help us determine the magnitude and position of reflections from transitions within the fixture, and we can measure the quality of the calibration standards. As long as we have enough spatial resolution, we can see the reflections of the connector launches independently from the reflections of the calibration standards. It is very easy to determine which transition is which, as the designer can place a probe on a transition and look for a large spike on the TDR trace.

With time-domain gating, we can isolate various sections of the fixture and see the effects in the frequency domain. For example, we can choose to look at just the connector launches (without interference from the reflections of the calibration standards), or just the calibration standards by themselves.

Another application for TDR is fault-location for coaxial cables in cellular and CATV installations. We can use TDR in these cases to precisely determine the location of cable faults such as crimps, poor connections, shorts, opens -- anything that causes a portion of the incident signal to be reflected.

TDR Basics Using a Network Analyzer

- start with broadband frequency sweep (often requires microwave VNA)
- use inverse-Fourier transform to compute time-domain
- resolution inversely proportionate to frequency span

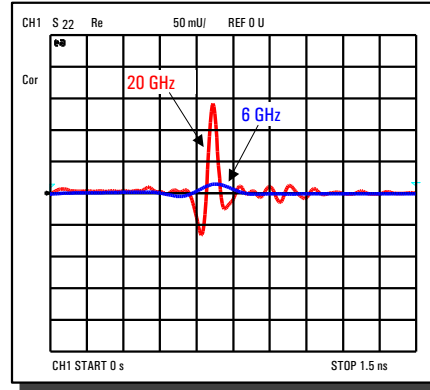
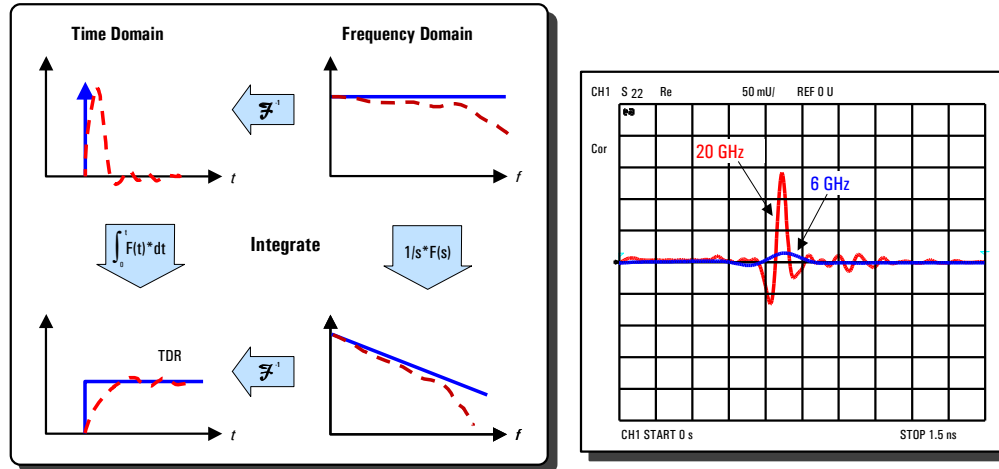

Network Analyzer Basics

 Agilent Technologies

www.agilent.com/find/backtobasics

Slide 97

TDR measurements using a vector network analyzer start with a broadband sweep in the frequency domain. The inverse-Fourier transform is used to transform frequency-domain data to the time domain. The figure on the left of the slide shows a simplified conceptual model of how a network analyzer derives time-domain traces. For step-response TDR, we want to end up at the lower left-hand plot. The network analyzer gathers data in the frequency domain (upper right) from a broadband sweep (note: all the data is collected from a reflection measurement). In effect, we are stimulating the DUT with a flat frequency input, which is equivalent to an impulse in the time domain. The output response of our DUT is therefore the frequency response of its impulse response. Since a step in the time domain is the integral of an impulse, if we integrate the frequency-response data of our DUT, we will have frequency-domain data corresponding to the step response in the time domain. Now, we simply perform an inverse-Fourier transform to get from the frequency domain to the time domain, and *voilà*, we have the step response. Note that we could also perform the inverse-Fourier transform first, and then integrate the time-domain data. The result would be the same. The actual math used in the network analyzer is somewhat more complicated than described above, in order to take care of other effects (one example is extrapolating a value for the DC term, since the analyzer doesn't measure all the way down to 0 Hz).

To get more resolution in the time domain (to separate transitions), we need a faster effective rise time for our step response. This translates to a sharper (narrower) effective impulse, which means a broader input-frequency range must be applied to our DUT. In other words, the higher the stop frequency, the smaller the distance that can be resolved. For this reason, it is generally necessary to make microwave measurements on the fixture to get sufficient resolution to analyze the various transitions. Providing sufficient spacing between transitions may eliminate the need for microwave characterization, but can result in very large fixtures. The plot above of a fixtured-load standard shows the extra resolution obtained with a 20 GHz sweep versus only a 6 GHz sweep.

Time-Domain Gating

- TDR and gating can **remove** undesired reflections (a form of **error correction**)
- Only useful for **broadband** devices (a load or thru for example)
- Define **gate** to only include DUT
- Use two-port calibration

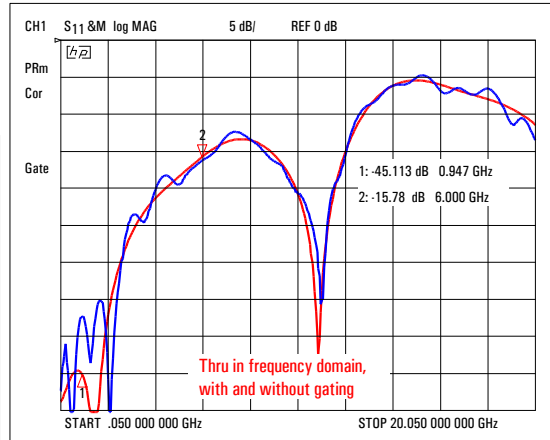
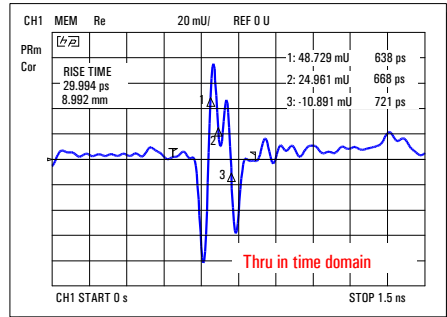

Network Analyzer Basics



Agilent Technologies

www.agilent.com/find/backtobasics

Slide 98

Gating can be used in conjunction with time-domain measurements to separate and remove undesirable reflections from those of interest. For example, gating can isolate the reflections of a DUT in a fixture from those of the fixture itself. This is a form of error correction. For time-domain gating to work effectively, the time domain responses need to be well-separated in time (and therefore distance). The gate itself looks like a filter in time, and has a finite transition range between passing and rejecting a reflection (similar to the skirts of a filter in the frequency domain).

The plots above show the performance of an in-fixture thru standard (without normalization). We see about a 7 dB improvement in the measurement of return loss at 947 MHz using time-domain gating – in this case, the through standard is quite good, having a return loss of 45 dB. The gating effectively removes the effects of the SMA connectors at either end of the test fixture.

Ten Steps for Performing TDR

1. Set up desired frequency range (need wide span for good spatial resolution)
2. Under SYSTEM, transform menu, press "set freq low pass"
3. Perform one- or two-port calibration
4. Select S11 measurement *
5. Turn on transform (low pass step) *
6. Set format to real *
7. Adjust transform window to trade off rise time with ringing and overshoot *
8. Adjust start and stop times if desired
9. For gating:
 - set start and stop frequencies for gate
 - turn gating on *
 - adjust gate shape to trade off resolution with ripple *
10. To display gated response in frequency domain
 - turn transform off (leave gating on) *
 - change format to log-magnitude *

** If using two channels (even if coupled), these parameters must be set independently for second channel*



Slide 99

Here is a summary of how to perform TDR measurements. Without such a checklist, it is easy to overlook some of the more subtle steps, resulting in confusing or misleading measurements. A one-port calibration is all that is needed when characterizing connectors and the open, short and load standards. A two-port calibration is needed to characterize the reflection or line impedance of the thru standard.

Time-Domain Transmission

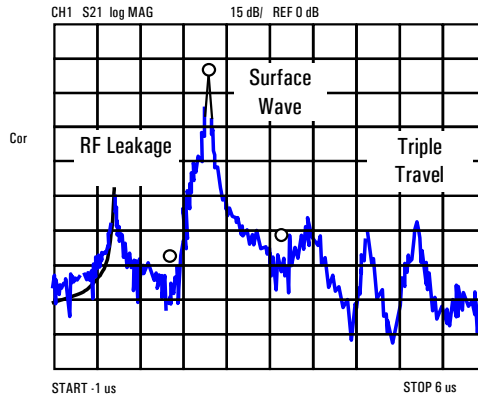
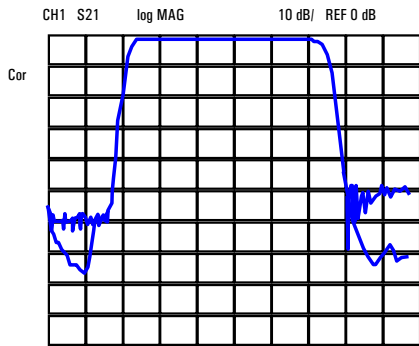
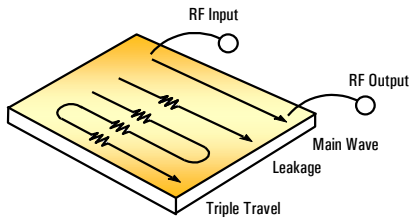

Network Analyzer Basics



Agilent Technologies

www.agilent.com/find/backtobasics

Slide 100

Time-domain transmission (TDT) is a similar tool which uses the transmission response instead of the reflection response. It is useful in analyzing signal timing in devices such as SAW filters. Gating is also useful in TDT applications. In the above example, a designer could look at the frequency response of the main surface wave without the effect of the leakage and triple-travel error signals.

Configurable Test Set - High Power Measurements

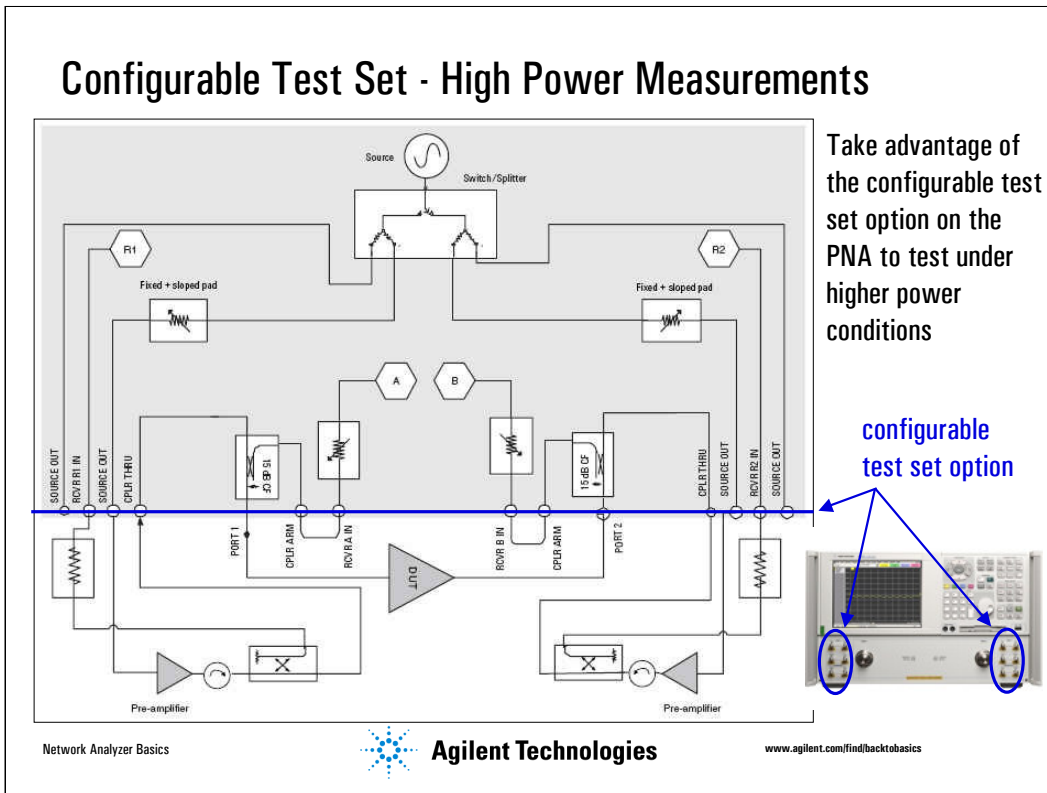

Take advantage of the configurable test set option on the PNA to test under higher power conditions

configurable test set option

Slide 101

The PNA series of network analyzers have option 014, configurable test set, which gives you access to various portions of the signal path by way of coaxial connectors on the front of the analyzer. This option gives you flexibility such as the case of measuring an amplifier under higher power conditions that can be supplied by the analyzers internal source or handled by the test set.

The above example shows a configuration for a two-way high power amplifier measurements. A pre-amplifier is added at each port to obtain higher power levels at the ports of the amplifier under test. Isolators are used to improve the load match and also protect the pre-amplifiers from high output power. Couplers and attenuators are used to attenuate the signals to power levels acceptable to the internal test set (to prevent damage and receiver compression).

Further information is found in application note AN1408-10 Recommendations for Testing High-Power Amplifiers.

Configurable Test Set - High-Dynamic Range Measurements

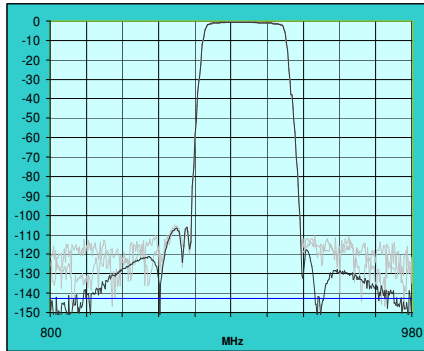

Take advantage of extended dynamic range with direct-receiver access

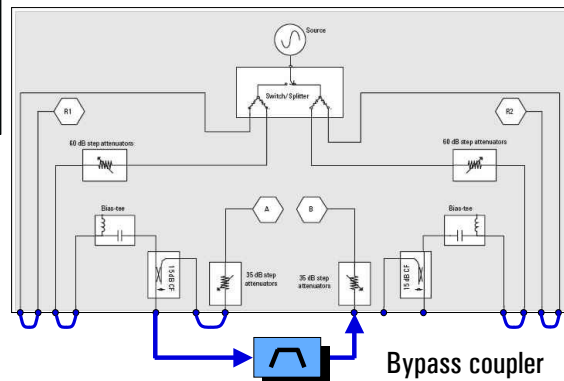

Network Analyzer Basics

 Agilent Technologies

www.agilent.com/find/backtobasics

Slide 102

Extended dynamic range filter measurements can be achieved by either bypassing or reversing the coupler at test port 2 (for forward transmission measurements). By reversing the port 2 coupler, the transmitted signal travels to the "B" receiver via the main arm of the coupler, instead of the coupled arm. This increases the effective sensitivity of the analyzer by around 12 dB. To take advantage of this increased sensitivity, the power level must be decreased in the passband, to prevent the receiver from compressing. This is easily done using a segmented sweep, where the power is set high in the stopbands (+10 dBm typically), and low in the passband (-6 dBm typically). The IF bandwidth can be widened for the passband segment to speed up the overall sweep. When the port 2 coupler is reversed, 2-port error correction can still be used, but the available power at port 2 is 12 dB lower than the normal configuration.

Direct access to the receiver (which also extends dynamic range) can be achieved with every PNA Series analyzer, by ordering Options 014 or H85 on the 8753, or Options 012 or O85 on the 8720 series. Agilent also offers a special option (H16) for the 8753 that adds a switch that can reverse the port-two coupler. The coupler can be switched to the usual configuration for normal operation.

Multiport Device Test

8753 H39



ENA Series – E507xB



PNA-L Series – N5230A

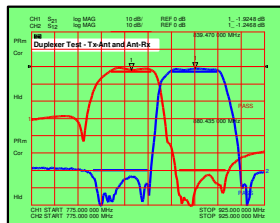
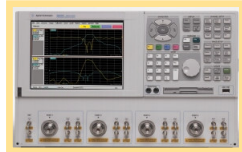

Network Analyzer Basics

Multiport analyzers and test sets:

- improve **throughput** by reducing the number of connections to DUTs with more than two ports
- allow **simultaneous** viewing of two paths (good for tuning duplexers)
- include **mechanical** or **solid-state** switches, **50** or **75** ohms
- degrade raw performance so **calibration** is a **must** (use two-port cals whenever possible)
- Agilent offers a variety of standard and custom multiport analyzers and test sets

87050E Multiport Test Set



E5091A Multiport Test Set



Agilent Technologies

www.agilent.com/find/backtobasics

Slide 103

High-volume tuning and testing of multiport devices (devices with more than two ports) can be greatly simplified by using a network analyzer with integrated 3 or 4 ports, or using a multiport test set between the DUT and the network analyzer. A single connection to each port of the DUT allows complete testing of all transmission paths and port reflection characteristics. Agilent multiport test systems eliminate time-consuming reconnections to the DUT, keeping production costs down and throughput up. By reducing the number of RF connections, the risk of misconnections is lowered, operator fatigue is reduced, and the wear on cables, fixtures, connectors, and the DUT is minimized.

Agilent offers a variety of multiport test systems, both standard and custom. Some, like the 8753 H39, which is targeted to duplexer manufacturers, have built-in multiport test sets. The ENA series E507xB can be configured with 2, 3, or 4 ports. For microwave applications there is the 4-port PNA-L network analyzer (N5230A). Custom test sets can be created in 50 and 75 ohms with a variety of connector types and switching configurations, to exactly suit a user's application.

For more information on multiport solutions visit;

www.agilent.com/find/multiport

www.agilent.com/find/ena

www.agilent.com/find/rfpna

www.agilent.com/find/pna

E5091A Standard Multiport Test Sets

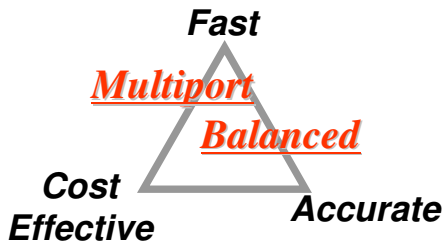
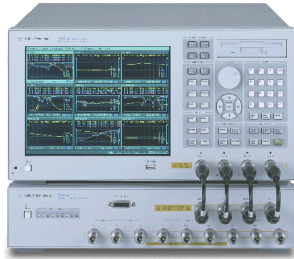

- For use with 4-Port ENA E507xB
- 50 Ω / 50 MHz to 8.5 GHz / 7 or 9 ports
- System is tailored for testing the antenna switch modules for mobile handsets
- Displaying 16 traces per channel shows all test results at once

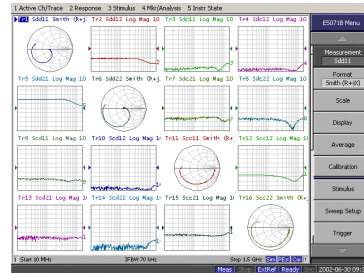

Network Analyzer Basics



Agilent Technologies

www.agilent.com/find/backtobasics

Slide 104

The ENA series of network analyzers can be configured with built-in 2, 3, or 4 ports. The 4-port ENA can be further extended to either 7 or 9 ports with the E5091A multiport test set.

For more information on ENA multiport solutions visit;

www.agilent.com/find/multiport

www.agilent.com/find/ena

87050E/87075C Standard Multiport Test Sets



Once a month:
perform a **Test Set Cal** with external standards to remove systematic errors in the analyzer, test set, cables, and fixture

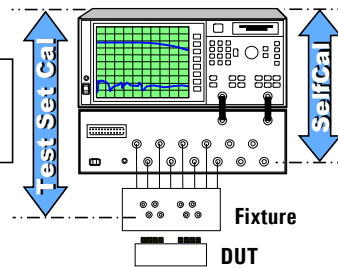

Once an hour:
automatically perform a **SelfCal** using internal standards to remove systematic errors in the analyzer and test set

- For use with 8712E family
- 50 Ω : 3 MHz to 2.2 GHz, 4, 8, or 12 ports
- 75 Ω : 3 MHz to 1.3 GHz, 6 or 12 ports
- Test Set Cal and SelfCal dramatically improve calibration times
- Systems offer fully-specified performance at test ports

Network Analyzer Basics



www.agilent.com/find/backtobasics

Slide 105

Agilent offers a line of standard multiport test sets that are designed to work with the 8712E series of network analyzers to provide a complete, low-cost multiport test system. The 87075C features specified performance to 1.3 GHz with 6 or 12 test ports (75 ohm), and the 87050E features specified performance to 2.2 GHz with 4, 8, or 12 test ports (50 ohm). These test sets contain solid-state switches for fast, repeatable, and reliable switching between measurement paths.

New calibration techniques can dramatically reduce the time needed to calibrate the test system. Test Set Cal is a mechanical-standards based calibration that eliminates redundant connections of reflection standards and minimizes the number of through standards needed to test all possible measurement paths. SelfCal is an internally automated calibration technique that uses solid-state switches to measure calibration standards located inside the test set. SelfCal executes automatically in just a few seconds (at a user-defined interval), restoring the measurement accuracy of the Test Set Cal. This effectively eliminates test-system drift, and greatly increase the interval between Test Set Cals. With SelfCal, a Test Set Cal needs to be performed only about once per month, unlike other test systems that typically require calibration once or twice a day. This combination can easily reduce overall calibration times by a factor of twenty or more, increasing the amount of time a test station can be used to measure components.

For more information about these multiport test systems, please visit www.agilent.com/find/multiport

Test Set Cal Eliminates Redundant Connections of Calibration Standards

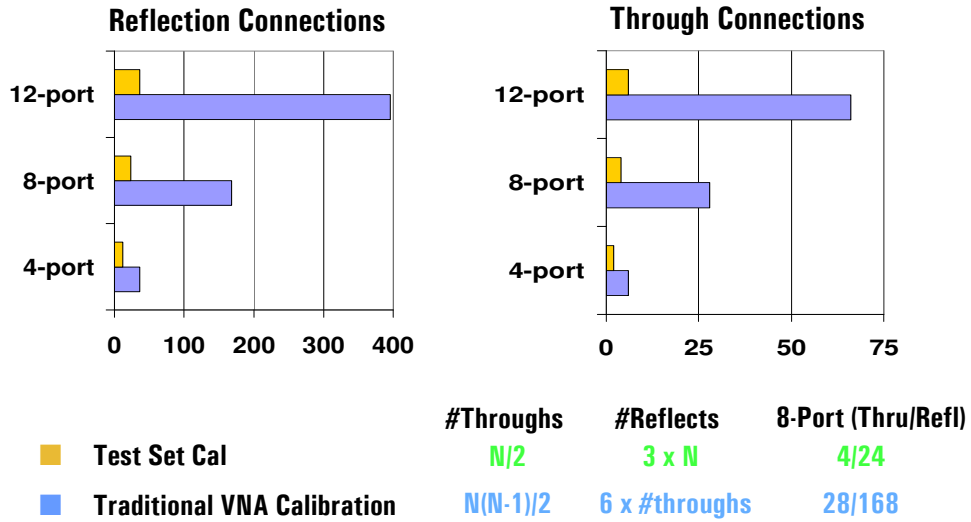

Network Analyzer Basics



www.agilent.com/find/backtobasics

Slide 106

This slide shows the decrease in the number of connections needed to fully calibrate the multiport test systems using Test Set Cal.

PNA Series plus External Test Set

- Test set controlled via GPIB and Agilent-supplied Visual Basic program executed from PNA Series analyzer
- Two port error correction available
- Z5623A H03
 - 3 port external test set
 - Solid-state switching for fast, repeatable measurements
- Z5623A H08
 - 8 port external test set
 - Mechanical switching for best RF performance
- 87050A/B, 87075A/B
 - Custom multiport test sets
 - 50 or 75 Ω

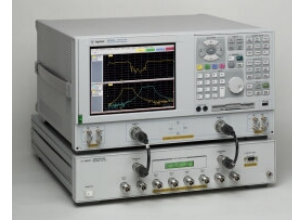

Network Analyzer Basics



www.agilent.com/find/backtobasics

Slide 107

Agilent has test sets that are specifically meant to work with the PNA Series of network analyzers, for the ultimate in measurement accuracy, speed, and convenience. The test sets are controlled by a Visual Basic program that runs internally in the network analyzer. The H03 features solid-state switching, and is aimed at duplexer testing. The H08 uses mechanical switches, and is suitable for low-volume manufacturing of base-station components. Other test sets with different port arrangements can be configured as well.

For more information on PNA series multiport solutions visit;

www.agilent.com/find/multiport

www.agilent.com/find/rfpna

www.agilent.com/find/pna

In-Fixture Measurements

Measurement problem: coaxial calibration plane is not the same as the in-fixture measurement plane

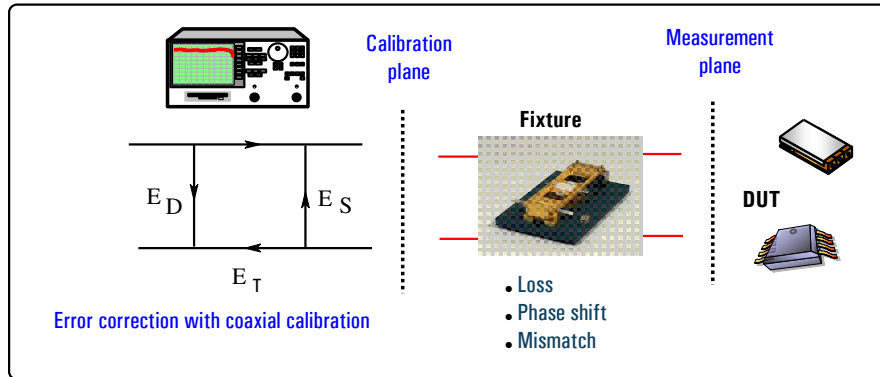

Slide108

More information about in-fixture measurements can be obtained from the following sources:

"In-Fixture Measurements Using Vector Network Analyzers", Application Note 1287-9, 5968-5329E

"Accurate Measurements of Packaged RF Devices", 1995 Device Test Seminar handout, 5963-5191E

"Specifying calibration standards for the 8510 network analyzer", Product Note 8510-5A, 5965-4352

Antenna - Typical Radar Cross-Section Configuration

Antenna Chamber

Features well suited for RCS applications:

- ✓ Excellent measurement sensitivity; -114 dBm
- ✓ Very fast frequency agility; 119 μ s per point
- ✓ Extremely long alias-free down-range resolution; 16,001 trace points
- ✓ Removable hard drive for security issues

Network Analyzer Basics Agilent Technologies www.agilent.com/find/backtobasics

Slide 109

Shown here is a typical Radar Cross-Section (RCS) measurement configuration. It is very similar to the hundreds of 8720 and 8530 configurations currently in use.

RCS measurements require: Excellent sensitivity, fast frequency agility, and fast data acquisition times.

Prior network analyzer based RCS configurations utilized either a harmonic sampler or mixer based frequency downconversion. When choosing between the two, one could either optimize measurement speed, or measurement sensitivity.

Mixer downconversion (85301B): provided the best sensitivity of -113 dBm, but at the cost of a relatively slow stepped frequency agility speed of 6-8 mS per point.

Harmonic sampler downconversion (8511): Provides the best ramp sweep frequency agility of 230 μ s per point, but at a tradeoff of a lower measurement sensitivity of -98 dBm.

The new family of PNA network analyzers makes a significant contribution to RCS measurements, providing both excellent measurement sensitivity and fast frequency agility. The PNA utilize mixer based downconversion technology to provide excellent measurement sensitivity of -114 dBm, and very fast frequency agility speeds of 119 μ s per frequency point.

Summary: The RCS range designer no longer has to choose between fast frequency agility or optimizing measurement sensitivity. The new PNAs provide both the excellent sensitivity, fast frequency agility, and fast data acquisition speeds required by RCS ranges in one new instrument.

For more information refer to White Paper *Antenna and RCS Measurement Configurations Using PNA Series Microwave Network Analyzers*.

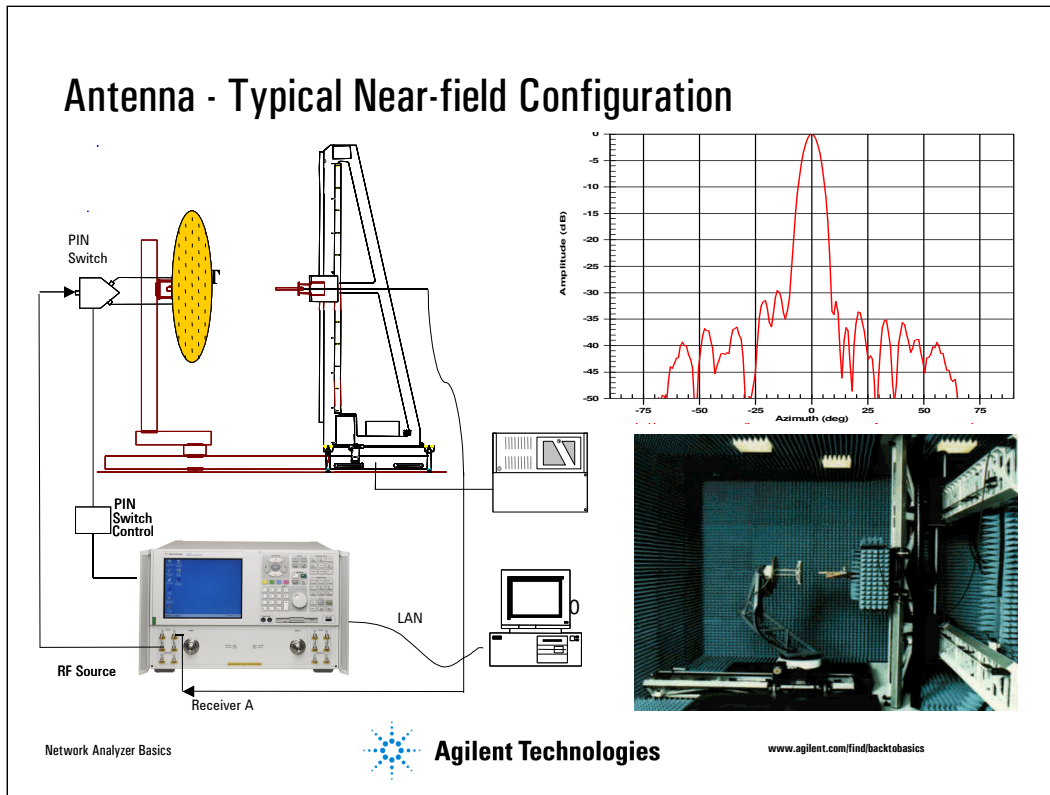

Slide 110

This figure illustrates a basic near-field antenna measurement configuration utilizing a PNA network analyzer. It is very similar to a configuration utilizing an 8720 network analyzer.

Performance enhancements of the PNA are as follows:

1. Faster data acquisition:

PNA is 2.6 Times faster than the 8720
PNA is 119 μ S vs 8720 is 310 μ S

2. Improved measurement sensitivity:

24 dB improvement in measurement sensitivity over the 8720
PNA uses mixer-based downconversion
8720 uses harmonic sampler based downconversion

3. User selectable bandwidth:

Optimize the measurement speed vs. measurement sensitivity

4. Faster frequency agility:

Typical PNA frequency stepping speeds are 20 times faster than 8720

Summary: For basic near-field measurements that are not data intensive, there will be little noticeable difference in total measurement times between PNA and 8720. However, for data intensive near-field measurements, the performance enhancements of the PNA will significantly reduce the total measurement time.

Antenna - Large Scale Near-field Configuration

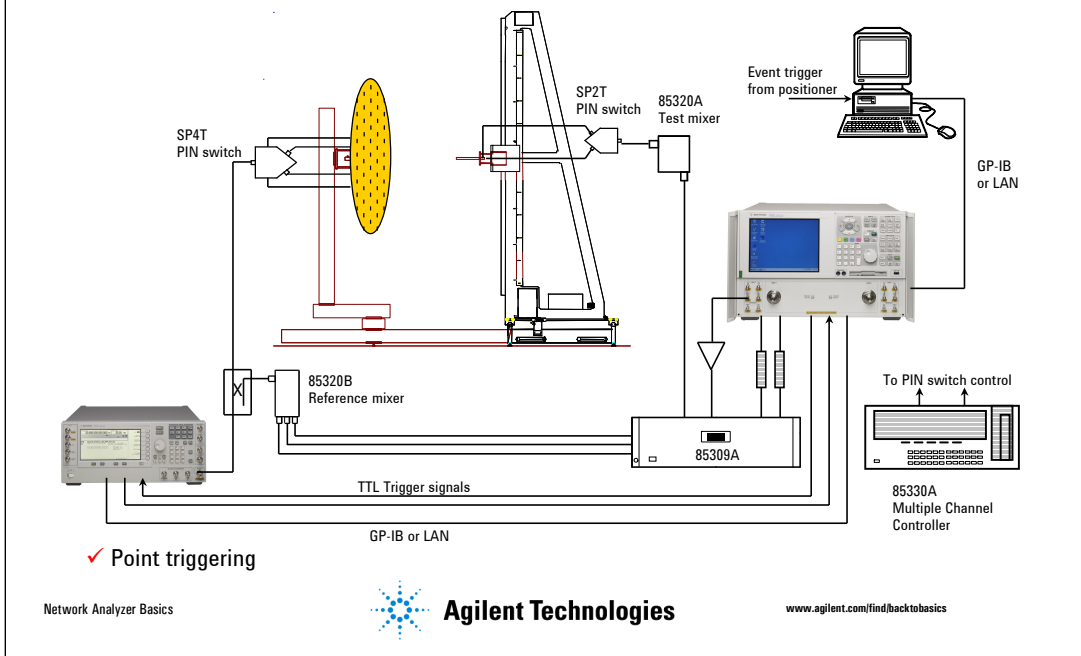

Slide 111

For large-scale near-field configurations where cable losses become significant, an external source and external mixer configuration such as shown here can be utilized. This overcomes the cable loss concerns, and provides very good performance.

Utilizing the source frequency list and direct trigger signals between the PNA and source provides the best frequency stepping speed. The system measurement speed is often determined by the remote source which is the slowest resource in the system. This could be enhanced with a faster microwave source or possibly utilizing a second PNA for the remote source.

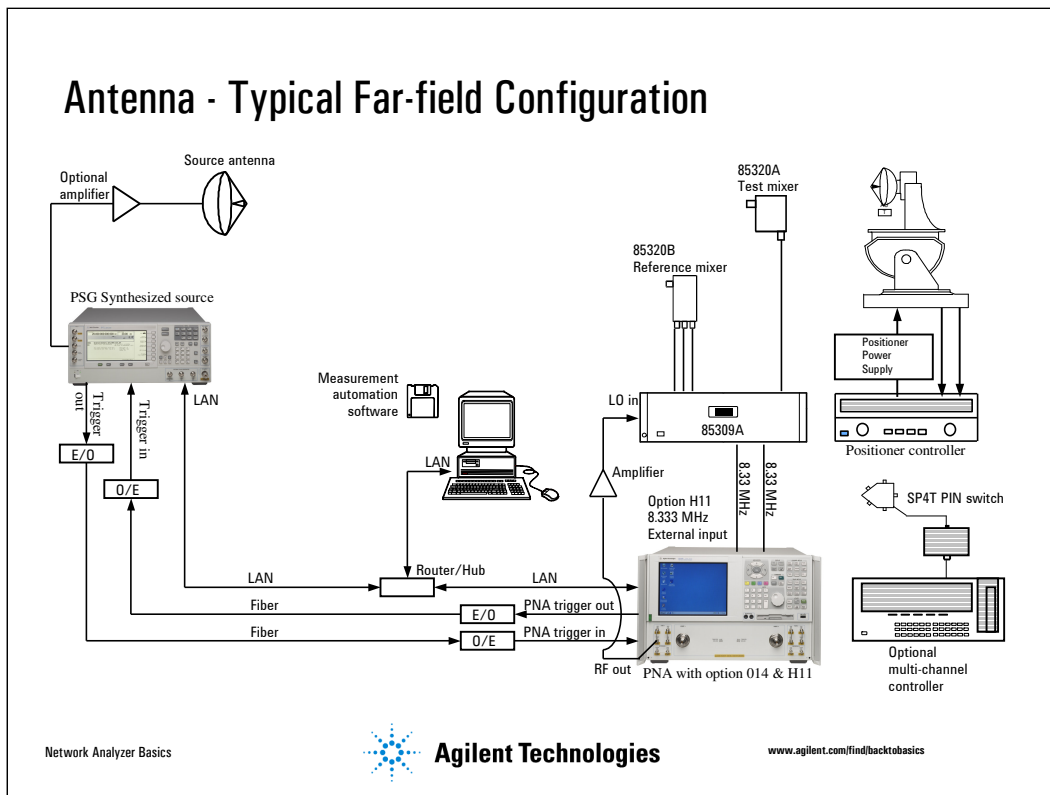

Slide 112

Shown here is a possible setup for a PNA in a far-field antenna configuration. The configuration is very similar to the existing 85301B systems, with some slight differences.

The far-field PNA configuration utilizes the same 85320A/B external mixers, and the 85309A LO/IF distribution unit to provide the first downconversion. However, the first downconversion is to an IF frequency of 8.333 MHz, which is the second IF frequency of the PNA. Utilizing option H11, direct IF access, on the PNA allows direct access to the second downconversion stage in the PNA via rear panel connectors. By utilizing this second IF downconversion technique in the PNA, the noise figure is reduced, which allows achieving the excellent measurement sensitivity.

As is the case for all far-field antenna ranges, controlling a remote microwave source across a significant distance is always a concern. This configuration utilizes a PSG microwave source, utilizing TTL handshake triggers between the PNA and the PSG source.

With the advent of relatively low-cost fiber optic transducers, this is a technology that could/should be investigated to provide long-distance TTL transmission signals across a far-field antenna range.

The frequency stepping speed of a far-field antenna range will be source dependent. There are many different sources which could be utilized. With the PSG source, we measured frequency stepping speeds of between 4-6 mS depending on step sizes.

Why Test Under Pulsed Conditions?

- **Device may behave differently between CW and pulsed stimuli**

- Bias changes during pulse might affect RF performance
- Overshoot, ringing, droop may result from pulsed stimulus
- Measuring behavior within pulse is often critical to characterizing system operation (radars for example)

- **CW test signals would destroy DUT**

- High-power amplifiers not designed for continuous operation
- On-wafer devices often lack adequate heat sinking
- Pulsed test-power levels can be same as actual operation

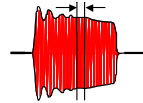

•CDMA Power Amplifier module
•4.0 x 4.0 x 1.1 mm package
•28.5 dBm linear output power



Network Analyzer Basics



Agilent Technologies

www.agilent.com/find/backtobasics

Slide 113

Testing under pulsed-RF conditions is very valuable for devices that will be used in a pulsed-RF environment, since the behavior of many components differs between CW and pulsed-stimulus test. For example, the bias of an amplifier might change during a pulse. Or, the amplifier might exhibit overshoot, ringing, or droop as a result of being stimulated with a pulse. Also, particularly for radar systems, measuring the transient behavior within the pulse is critical for understanding system operation. Unintended modulation on the pulse (UMOP) can cause several system problems in radar systems:

- decreased clutter rejection
- decreased target velocity resolution
- undesired spread of phased-array-antenna beam patterns
- unintentional identification of a radar system

Characterizing the amplitude and phase versus time in the pulse is crucial to characterizing and containing UMOP.

Many devices simply cannot be tested with CW stimulus at the desired power levels. For example, many high-power amplifiers are not designed to handle the power dissipation of continuous operation, and when testing on-wafer, many devices lack sufficient heat sinking for CW test. Testing with pulses allows the test-power levels of these devices to be consistent with actual operation (which gives more realistic characterization), without thermal-induced damage. Characterizing these devices on-wafer prevents devices that don't meet their specifications from being packaged, saving the manufacturer considerable time and money.

Visit www.agilent.com/find/pulsedrf for Pulsed RF measurement solutions.

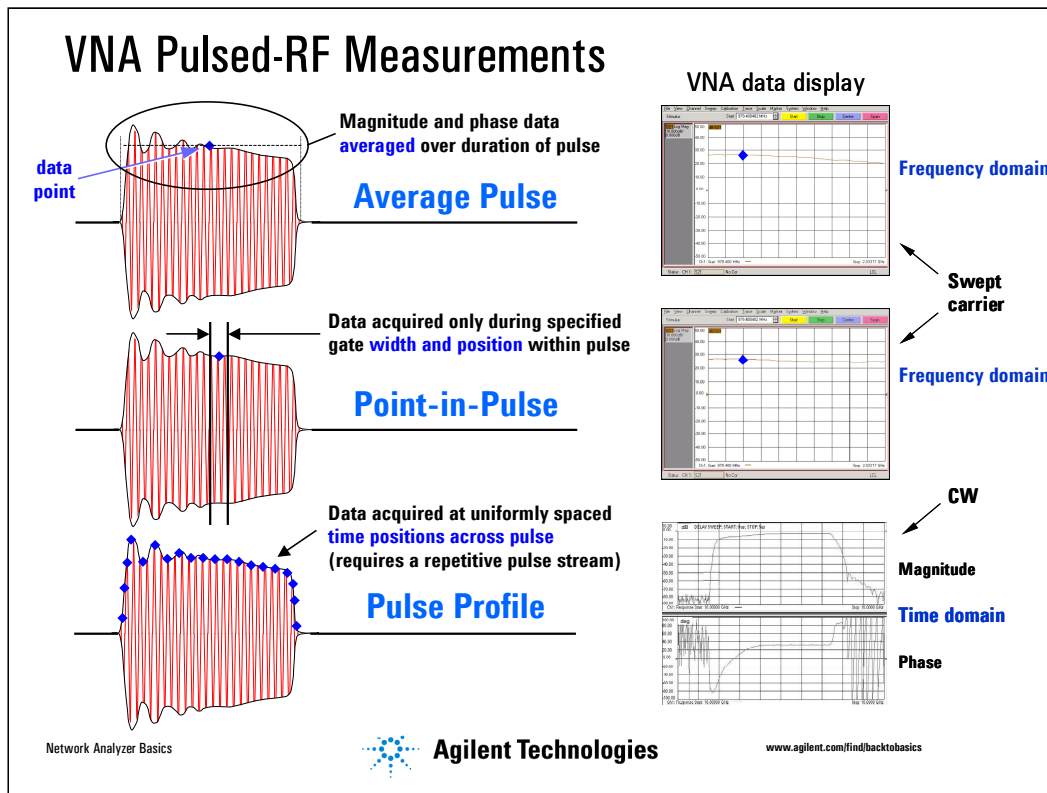

Slide 114

This slide shows three major types of pulsed-RF measurements. The first two are pulsed S-parameter measurements, where a single data point is acquired for each carrier frequency. The data is displayed in the frequency domain as magnitude and/or phase of transmission and reflection. Average pulse measurements make no attempt to position the data point at a specific point within the pulse. For each carrier frequency, the displayed S-parameter represents the average value of the pulse. This occurs for example when doing narrowband detection without any receiver gating. Point-in-pulse measurements result from acquiring data only during a specified gate width and position (delay) within the pulse. There are different ways to do this in hardware, depending on the type of detection used, which will be covered later. Pulse profile measurements display the magnitude and phase of the pulse versus TIME, instead of frequency. The data is acquired at uniformly spaced time positions across the pulse. This is achieved by varying the delay of measurement with respect to the pulse while the carrier frequency is fixed at some desired frequency.

For all of these measurements, there may not be a one-to-one correlation between data points and the actual number of pulses that occur during the measurement. For example, with narrowband detection, many pulses can occur before enough data is collected for each data point. With wideband detection, the analyzer may not be able to completely process a data point during the time between pulses, resulting in skipped pulses between displayed data points.

Further information is found in application note AN1408-11 Accurate Pulsed Measurements.

Pulsed S-parameter Measurement Modes

- **Wideband/synchronous acquisition**

- Majority of pulse energy is contained within receiver bandwidth
- Incoming pulses and analyzer sampling are synchronous
- Pulse is “on” for duration of data acquisition
- No loss in dynamic range for small duty cycles (long PRI's), but there is a lower limit to pulse width

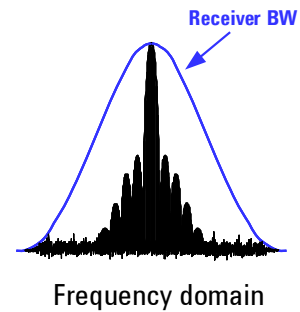
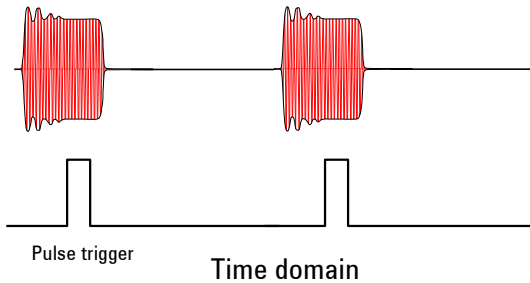

Network Analyzer Basics



www.agilent.com/find/backtobasics

Slide 115

Wideband detection can be used when the majority of the pulsed-RF spectrum is within the bandwidth of the receiver. In this case, the pulsed-RF signal will be demodulated in the instrument, producing baseband pulses. This detection can be accomplished with analog circuitry or with digital-signal processing (DSP) techniques. With wideband detection, the analyzer is synchronized with the pulse stream, and data acquisition only occurs when the pulse is in the “on” state. This means that a pulse trigger that is sync’d to the PRF must be present, and for this reason, this technique is also called synchronous acquisition mode. 8510-based systems had a built-in pulse generator to synchronize the data acquisition, while the PNA relies on external pulse generators.

The advantage of the wideband mode is that there is no loss in dynamic range when the pulses have a low duty cycle (long time between pulses). The measurement might take longer, but since the analyzer is always sampling when the pulse is on, the signal-to-noise ratio is essentially constant versus duty cycle. The disadvantage of this technique is that there is a lower limit to measurable pulse widths. As the pulse width gets smaller, the spectral energy spreads out -- once enough of the energy is outside the bandwidth of the receiver, the instrument cannot detect the pulses properly. Another way to think about it in the time domain is that when the pulses are significantly shorter than the rise time of the receiver, they cannot be detected.

Pulsed S-parameter Measurement Modes

• Narrowband/asynchronous acquisition

- Extract central spectral component only; measurement appears CW
- Data acquisition is not synchronized with incoming pulses (pulse trigger not required)
- Sometimes called “high PRF” since normally, $PRF \gg IF$ bandwidth
- “Spectral nulling” technique achieves wider bandwidths and faster measurements
- No lower limit to pulse width, but dynamic range is function of duty cycle

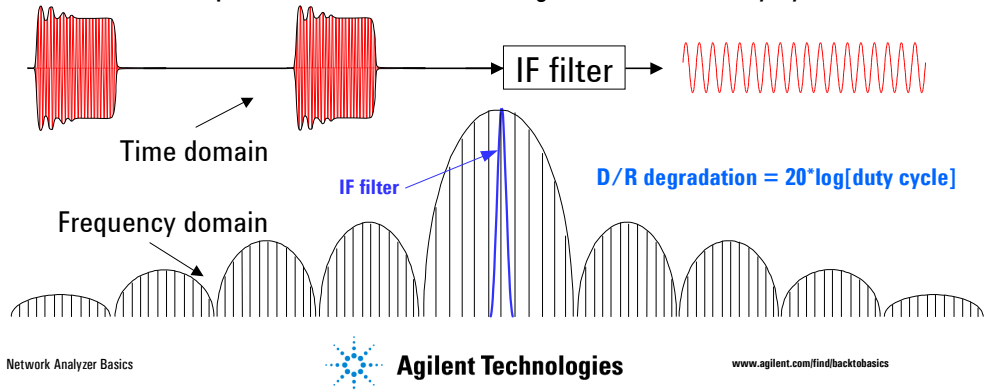

Slide 116

Narrowband detection is used when most of the pulsed-RF spectrum is outside the bandwidth of the receiver. With this technique, all of the pulse spectrum is removed by filtering except the central frequency component, which represents the frequency of the RF carrier. After filtering, the pulsed RF signal appears as a sinusoid or CW signal. With narrowband detection, the analyzer samples are not synchronized with the incoming pulses (therefore no pulse trigger is required), so the technique is also called asynchronous acquisition mode. Usually, the PRF is high compared to the IF bandwidth of the receiver, so the technique is also sometimes called the “high PRF” mode.

Agilent has developed a novel way of achieving narrowband detection using wider IF bandwidths than normal, by using a unique “spectral-nulling” technique that we will explain in the following slides. This technique lets the user trade dynamic range for speed, with the result almost always yielding faster measurements than those obtained by conventional filtering.

The advantage to narrowband detection is that there is no lower pulse-width limit, since no matter how broad the pulse spectrum is, most of it is filtered away anyway, leaving only the central spectral component. The disadvantage to narrowband detection is that measurement dynamic range is a function of duty cycle. As the duty cycle of the pulses gets smaller (longer time between pulses), the average power of the pulses gets smaller, resulting in less signal-to-noise ratio. In this way, measurement dynamic range decreases as duty cycle decreases. This phenomenon is often called “pulse desensitization”. The degradation in dynamic range (in dB) can be expressed as $20 \cdot \log(\text{duty cycle})$.

Spectral nulling acquisition (Narrowband)

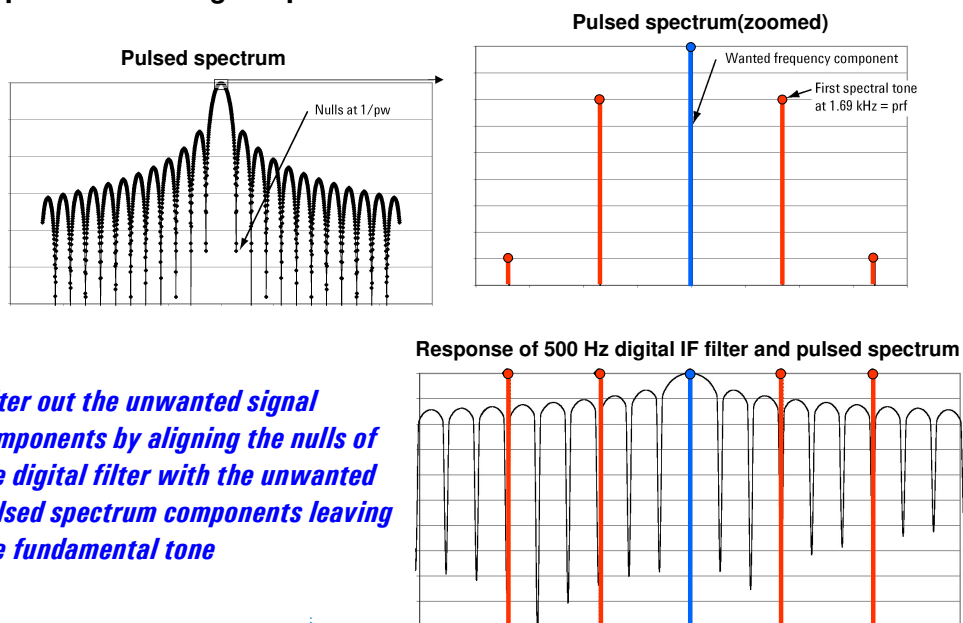

Network Analyzer Basics



Agilent Technologies

www.agilent.com/find/backtobasics

Slide 117

Spectral nulling is usually used when the pulse width is less than the minimum time required to digitize and acquire one discrete data point. Therefore multiple pulses must be captured for one data point acquisition. There is no strict synchronization between the individual incoming pulses and the time domain sampling of the analyzer. The frequency domain representation of the pulsed signal has discrete PRF tones that can be filtered out, leaving the fundamental tone which carries the measurement information. During the downconversion process in the analyzer, filtering is applied to reject unwanted noise and signal components.

The digital filter has nulls which are periodically spaced in the frequency domain. The period of these nulls is proportional to the sample rate of the receiver and the architecture of the digital filter. Using the microwave PNA we are able to filter out the unwanted signal components by aligning the nulls of the digital filter with the unwanted pulsed spectrum components leaving the fundamental tone. One advantage of this filtering technique is that the nulls of the filter are very deep and provide substantial rejection of the pulsed spectral components. Another advantage is that the nulls can be placed in close proximity to the fundamental tone because the transition regions at the nulls are very abrupt.

Spectral nulling acquisition Hardware configuration example

Pulse Generators:

- *Two output channels used to drive internal receiver (A, B) gates for point-in-pulse.*
- *One output channel used to drive modulator.*

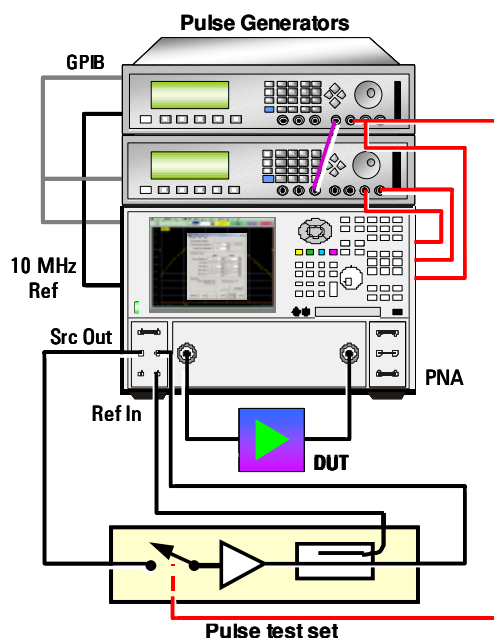

Network Analyzer Basics

 Agilent Technologies

www.agilent.com/find/backtobasics

Slide 118

Gate switches (modulators) are placed in front of the source and receivers where the delay and width of each of these gates can be set up independently. This pulses the analyzer's internal source and provides time gating for the receivers to do point-in-pulse and pulse profiling as the following section illustrates. The external modulators and pulse generators largely define pulse width limitations. The pulse generator must have a phase-lock loop (PLL) reference (10 MHz) input to lock the analyzer and pulse generator to the same time base. This is essential to make sure the frequency domain components of the filter and pulsed spectrum are locked together during alignment of nulls with PRF components.

In this particular configuration an external coupler is used to couple back the pulsed source signal to the reference receiver. This is beneficial when measuring ratioed parameters because any deviations in the external components after calibration will have minimal effect on the measurement results. Both the measurement and reference receiver will see the same deviations. A modulator is placed after the source and must have a frequency response equal to the DUT requirements (i.e. it must be able to pass the signal from the source with minimum attenuation). An amplifier may be placed after the modulator to provide a constant source match during measurement and calibration, and may also be used to increase the pulsed signal power. An isolator may be required (before the modulator) to isolate the analyzer source from the modulator, so that when the modulator is in the off state (no energy passing through modulator) that any high reflections, due to the off state match of the modulator, are minimized before reaching the analyzer. A high-pass filter may also be required (after the modulator) to filter out any video-feedthrough¹, generated by the modulator, which may interfere with the operation of the analyzer.

Measurement results

Pulse parameters

- Pulse repetition freq = 45 KHz
- Pulse width = 300 ns
- Duty cycle = 1.35 %

• **Dynamic range loss:**
-37.4 dB ($20 * \log(\text{Duty Cycle})$)

• **Dynamic range gain:**
10 dB ($10 * \log(\# \text{ of averages})$)

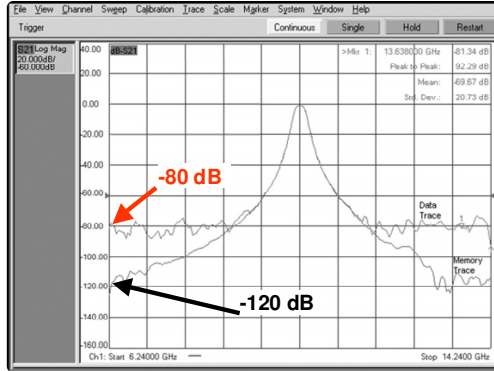

No averaging

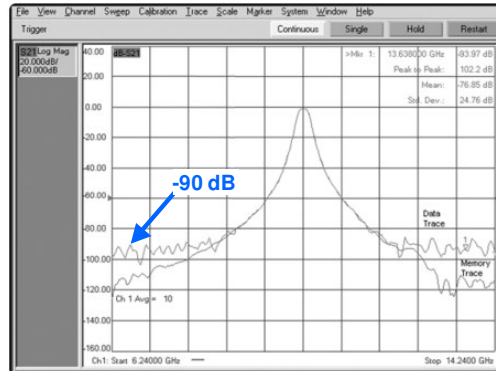

10 averaging

Network Analyzer Basics



Agilent Technologies

www.agilent.com/find/backtobasics

Slide 119

The left figure shows an S-parameter filter measurement comparison between a signal with no pulsing (memory trace) and a signal with a 300 ns pulse width (data trace) both at similar IF bandwidth settings. For a 300 ns pulse width, the spectral nulling mode is utilized. With 1.35% duty cycle, we have effectively reduced our specified dynamic range by 37.4 dB ($20 * \log(\text{Duty Cycle})$). This can be visualized by comparing the rejection of the memory trace with that of the data trace at the marker. The data trace is showing a stop band rejection figure of approximately 80 dB. The memory trace is showing rejection of approximately 115 dB which is a 35 dB difference corresponding to the 37.4 dB duty cycle loss. If required one can gain back 10 dB ($10 * \log(\# \text{ of averages})$) by applying 10 averages to the measurement(see right figure).

The results show that accurate pulsed measurements can be made with a microwave VNA. Both the Synchronous Pulse Acquisition and Spectral Nulling modes offer flexible alternatives for measuring the pulsed S-parameters of components. Very narrow pulse widths ($< 1 \mu\text{s}$) can be used as long as the duty cycle is large enough for acceptable measurement dynamic range. The use of the spectral nulling mode, largely offset the limitations of using a narrowband detection technique for pulsed measurements.

Beyond 67 GHz ...

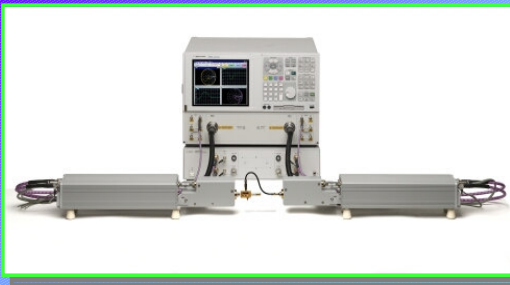

N5250A – 10 MHz to 110 GHz

- Based on 67 GHz PNA (E8361A)
- mmWave controller (N5260A) & test heads
- 1.0mm coaxial connectors
- Same firmware & features of PNA
- Option for bias tees

Banded mmWave to 325 GHz

- Microwave PNA (E836xB with options H11, UNL, O14, O80, and O81)
- mmWave controller (N5260A)
- Oleson Microwave Labs (OML) VNA2 test head;
 - WR-15: 50 – 75 GHz
 - WR-12: 60 – 90 GHz
 - WR-10, WR-8, WR-6, WR-5,
 - WR-4: 170 – 260 GHz
 - WR-3: 220 – 325 GHz

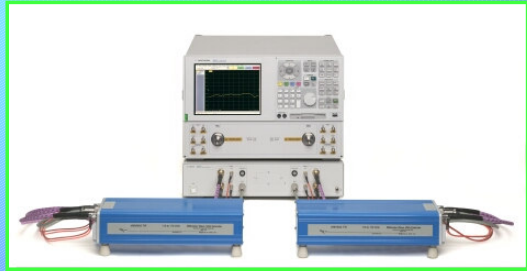

Network Analyzer Basics



Agilent Technologies

www.agilent.com/find/backtobasics

Slide 120

There are several PNA based solutions for frequencies above 67 GHz. These include the N5250A system, covering 10 MHz to 110 GHz in one sweep, and the banded millimeter-wave solutions using the N5260A test set controller and VNA2 series waveguide band test head modules from Oleson Microwave Labs (OML).

For more information please visit:

www.agilent.com/find/pna

www.oml-mmw.com

Materials Measurements

- Development and characterization of materials
- Several measurement techniques
 - ✓ Parallel Plate
 - ✓ Coaxial Probe
 - ✓ Transmission Line
 - ✓ Free-Space
 - ✓ Resonant Cavity
- 85070E dielectric probe kit
- 85071E materials measurement software



Coaxial Probe

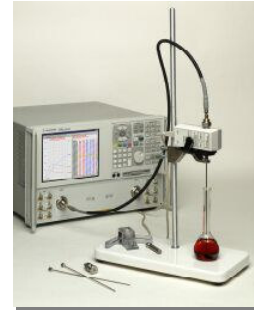

Solids/Semi-Solids/Liquids

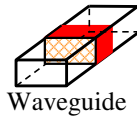

Waveguide



Coax

Transmission Line

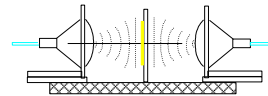

Free-Space

Network Analyzer Basics



www.agilent.com/find/backtobasics

Slide 121

Complex permittivity and permeability are determined by a material's molecular structure, so they can be related to other properties of interest as well. Measuring them can provide critical insight to applications in many industries. It can be useful in all stages of a product's lifecycle: design, incoming inspection, process monitoring, and quality assurance. For example, it is useful for improving ferrite, radome, and absorber designs. It can provide important information about materials used in state-of-the-art RF and microwave electronic components. Even biomass, bulk density, bacterial content, and chemical concentration can be related to a material's electromagnetic properties. There are several techniques used to measure the characteristics of materials. These techniques include parallel plate, coaxial probe, transmission line, free space, and resonant cavity. Some techniques are better suited for solid materials with certain sample thickness and other techniques are better for liquids.

For more information on solutions for material measurements please visit;

www.agilent.com/find/materials

Characterizing Crystal Resonators/Filters

E5100A/B Network Analyzer

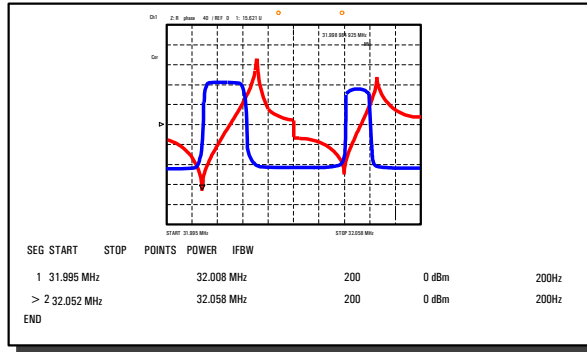
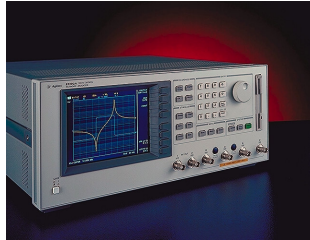

Example of crystal resonator measurement

Network Analyzer Basics



www.agilent.com/find/backtobasics

Slide 122

More information about measuring crystal resonators and filters can be obtained from the following sources:

"Crystal Resonators Measuring Functions of E5100A/B Network Analyzer", Product Note, (5965-4972E)

Agenda

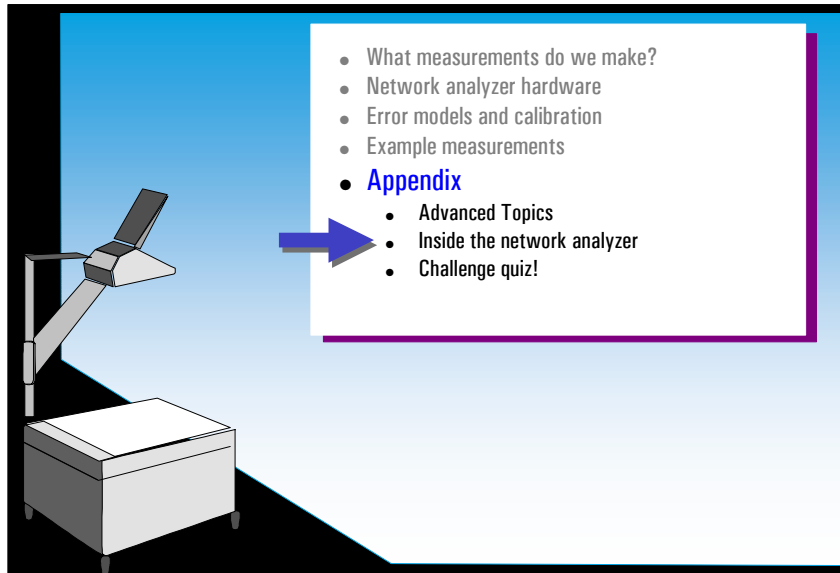

- What measurements do we make?
- Network analyzer hardware
- Error models and calibration
- Example measurements
- **Appendix**
 - Advanced Topics
 - Inside the network analyzer
 - Challenge quiz!

Network Analyzer Basics



www.agilent.com/find/backtobasics

Slide 123

This next section goes into more detail about the inside workings of vector network analyzers.

Directional Coupler *Directivity*

$$\text{Directivity} = \frac{\text{Coupling Factor}_{(\text{fwd})} \times \text{Loss}_{(\text{through arm})}}{\text{Isolation}_{(\text{rev})}}$$

$$\text{Directivity (dB)} = \text{Isolation (dB)} - \text{Coupling Factor (dB)} - \text{Loss (dB)}$$

Examples:

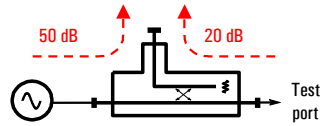

$$\text{Directivity} = 50 \text{ dB} - 20 \text{ dB} = 30 \text{ dB}$$

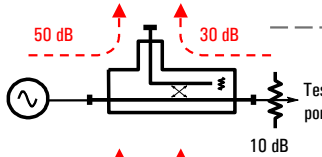

$$\text{Directivity} = 50 \text{ dB} - 30 \text{ dB} - 10 \text{ dB} = 10 \text{ dB}$$

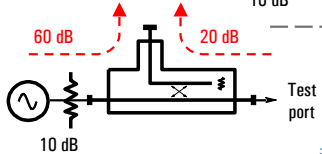

$$\text{Directivity} = 60 \text{ dB} - 20 \text{ dB} - 10 \text{ dB} = 30 \text{ dB}$$

Network Analyzer Basics



Agilent Technologies

www.agilent.com/find/backtobasics

Slide 124

One of the most important parameter for couplers is their directivity. Directivity is a measure of a coupler's ability to separate signals flowing in opposite directions within the coupler. It can be thought of as the dynamic range available for reflection measurements. Directivity can be defined as:

$$\text{Directivity (dB)} = \text{Isolation (dB)} - \text{Forward Coupling Factor (dB)} - \text{Loss (through-arm) (dB)}$$

(Note: this definition deviates somewhat from the traditional definition of directivity for a dual directional coupler, which is simply the forward-coupling factor divided by the reverse-coupling factor).

In the upper example in the above slide, our coupler exhibits a directivity of 30 dB. This means that during a reflection measurement, the directivity error signal is 30 dB below the desired signal (when measuring a device with full reflection or $\rho = 1$). The better the match of the device under test, the more measurement error the directivity error term will cause.

The slide also shows the effect of adding attenuators to the various ports of the coupler. The middle example shows that adding attenuation to the test port of a network analyzer reduces the raw (uncorrected) directivity by twice the value of the attenuator. While vector-error correction can correct for this, the stability of the calibration will be greatly reduced due to the degraded raw performance.

The lower example shows that adding an attenuator to the source side of the coupler has no effect on directivity. This makes sense since directivity is not a function of input-power level.

Adding an attenuator to the coupled port (not shown) affects both the isolation and forward-coupling factor by the same amount, so directivity is also unaffected.

One Method of Measuring Coupler Directivity

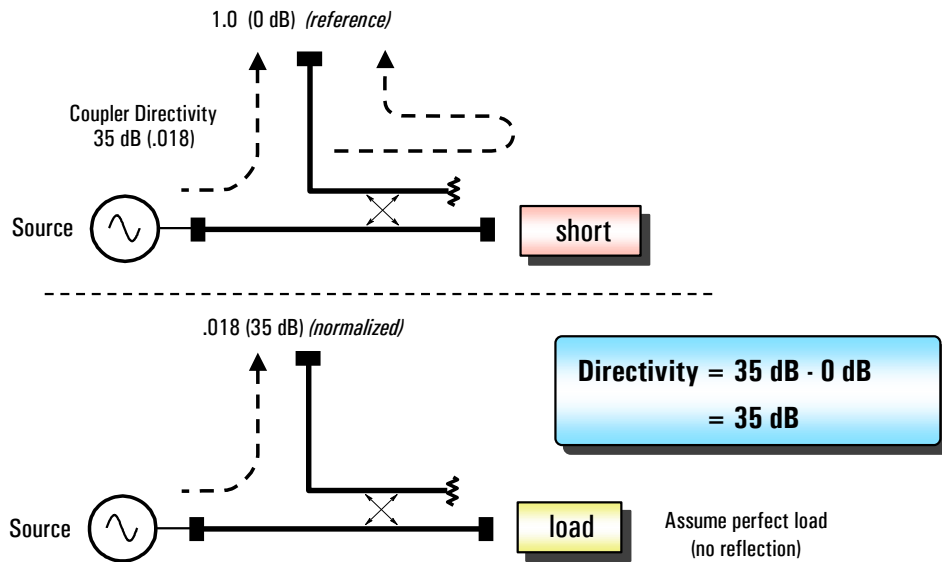

Network Analyzer Basics

 **Agilent Technologies**

www.agilent.com/find/backtobasics

Slide 125

This is one method of measuring directivity in couplers (or in a network analyzer) that doesn't require forward and reverse measurements. First we place a short at the output port of the main arm (the coupler is in the reverse direction). We normalize our power measurement to this value, giving a 0 dB reference. This step accounts for the coupling factor and loss. Next, we place a (perfect) load at the coupler's main port. Now, the only signal we measure at the coupled port is due to leakage. Since we have already normalized the measurement, the measured value is the coupler's directivity.

Directional Bridge

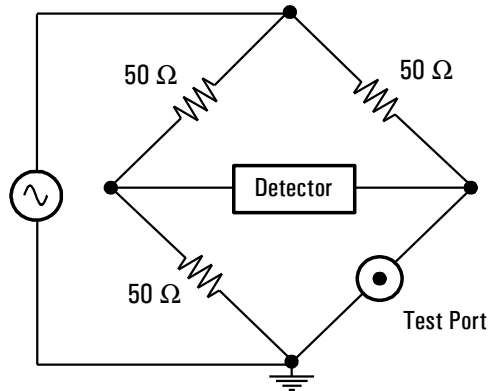

- 50-ohm load at test port balances the bridge -- detector reads zero
- Non-50-ohm load imbalances bridge
- Measuring magnitude and phase of imbalance gives complex impedance
- "Directivity" is difference between maximum and minimum balance

Network Analyzer Basics



www.agilent.com/find/backtobasics

Slide 126

Another device used for measuring reflected signals is the directional bridge. Its operation is similar to the simple Wheatstone bridge. If all four arms are equal in resistance ($50\ \Omega$ connected to the test port) a voltage null is measured (the bridge is balanced). If the test-port load is not $50\ \Omega$, then the voltage across the bridge is proportional to the mismatch presented by the DUT's input. The bridge is unbalanced in this case. If we measure both magnitude and phase across the bridge, we can measure the complex impedance at the test port.

A bridge's equivalent directivity is the ratio (or difference in dB) between maximum balance (measuring a perfect Z_0 load) and minimum balance (measuring a short or open). The effect of bridge directivity on measurement uncertainty is exactly the same as we discussed for couplers.

NA Hardware: Front Ends, Mixers Versus Samplers

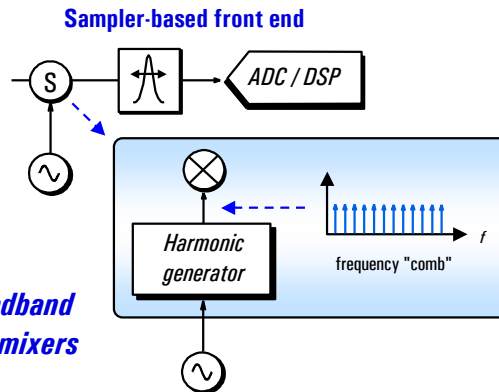
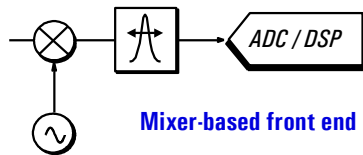
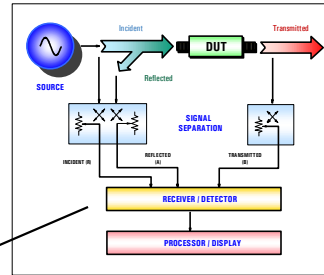

It is cheaper and easier to make broadband front ends using samplers instead of mixers

Network Analyzer Basics

 **Agilent Technologies**

www.agilent.com/find/backtobasics

Slide 127

Tuned receivers can be implemented with mixer- or sampler-based front ends. It is often cheaper and easier to make wideband front ends using samplers instead of mixers, especially for microwave frequency coverage. Samplers are used with many of Agilent's network analyzers, such as the 8753 series of RF analyzers, and the 8720 series of microwave network analyzers. The PNA Series uses mixers.

The sampler uses diodes to sample very short time slices of the incoming RF signal. Conceptually, the sampler can be thought of as a mixer with an internal pulse generator driven by the LO signal. The pulse generator creates a broadband frequency spectrum (often referred to as a "comb") composed of harmonics of the LO. The RF signal mixes with one of the spectral lines (or "comb tooth") to produce the desired IF. Compared to a mixer-based network analyzer, the LO in a sampler-based front end covers a much smaller frequency range, and a broadband mixer is no longer needed. The tradeoff is that the phase-lock algorithms for locking to the various comb teeth are more complex and time consuming.

Sampler-based front ends also have somewhat less dynamic range than those based on mixers and fundamental LOs. This is due to the fact that additional noise is converted into the IF from all of the comb teeth. Network analyzers with narrowband detection based on samplers still have far greater dynamic range than analyzers that use diode detection.

Mixers Versus Samplers: Time Domain

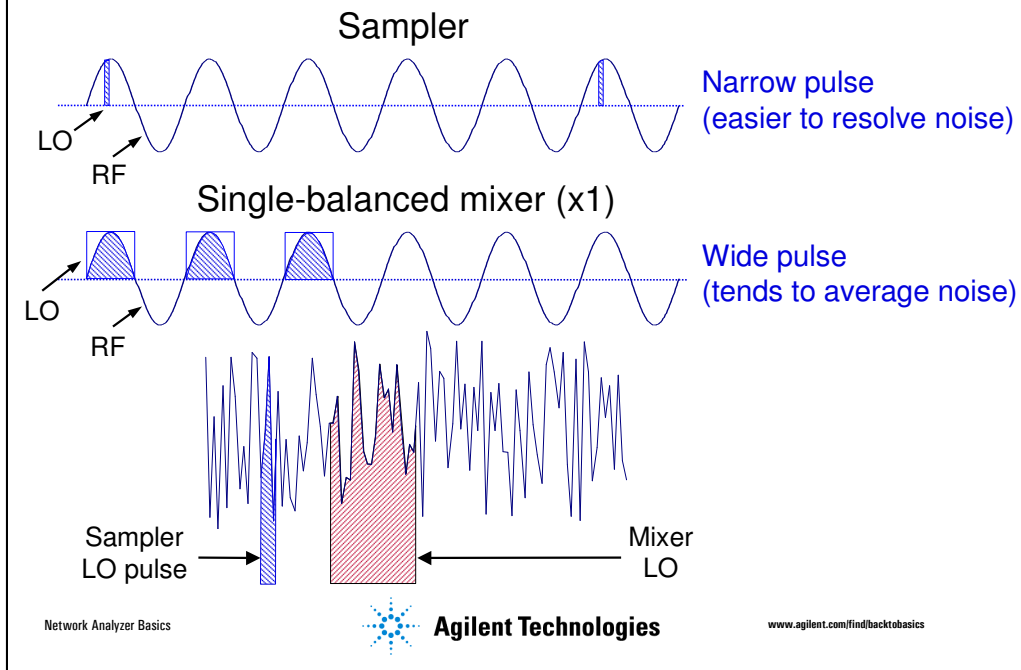

Slide 128

Let's look at the difference between samplers and mixers in the time domain first. Samplers use very narrow pulses to sample the RF input, compared to fundamental or third-order mixing. The narrow pulse is what makes a harmonic-rich LO in the frequency domain. This narrow pulse also gives more time-domain resolution, making it easier to follow the peaks and valleys of the noise. The result is that there is more noise on the IF signal.

In contrast, the mixer's LO is on for roughly half of the RF cycle, assuming a single-balanced mixer, which is typically the case for RF front ends. This longer period provides much more noise averaging. The result is less noise on the IF signal.

Mixers Versus Samplers: Frequency Domain

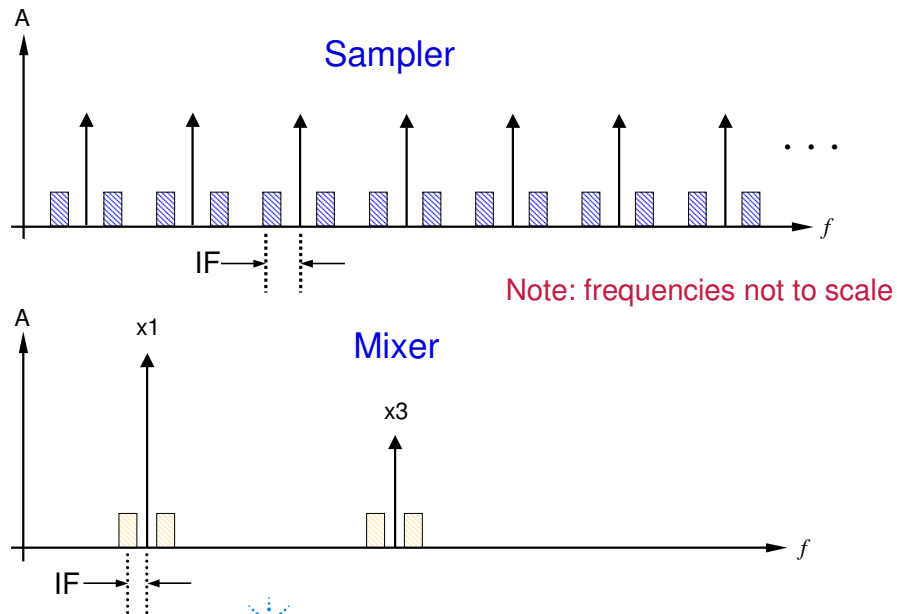

Slide 129

Now let's use a frequency-domain approach to explain why there is more noise conversion using samplers.

As was mentioned earlier, there are many harmonics of the LO in the frequency domain when using a sampler. Any noise present one IF away from every comb tooth, on either side, will be down-converted and detected in the IF. Since there are so many more harmonics, much more noise conversion takes place compared to using mixers, where noise is converted only around the fundamental and third harmonic of the LO. The noise multiplication effect from all of the sampler LO harmonics result in the sampler having a worse noise figure than the mixer. Typically, the difference is around 20 to 30 dB, depending on the frequencies involved.

Both the time domain and frequency domain approaches are valid ways at looking at the down-conversion process. They are just two different ways of explaining the same phenomenon.

Three Versus Four-Receiver Analyzers

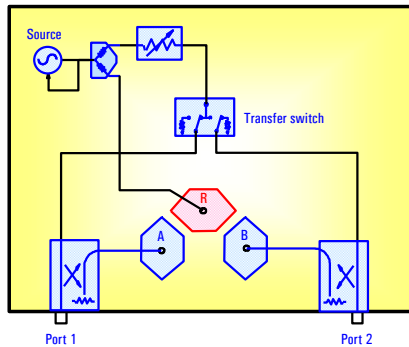

3 receivers

- more economical
- TRL*, LRM* cals only
- includes:
 - 8753ES
 - 8720ES (standard)

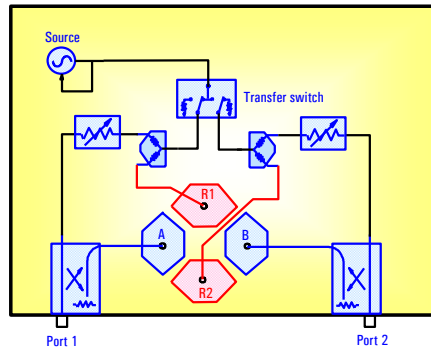

4 receivers

- more expensive
- true TRL, LRM cals
- includes:
 - PNA Series
 - 8720ES (option 400)
 - 8510C

Network Analyzer Basics



Agilent Technologies

www.agilent.com/find/backtobasics

Slide 130

As already discussed there are two main types of test sets, transmission/reflection and S-parameter test sets. The S-parameter test set has two basic test set architectures: one employing three receivers (either samplers or mixers) and one employing four receivers. The three-receiver architecture is simpler and less expensive, but the calibration choices are not as good. This type of network analyzer can do TRL* and LRM* calibrations, but not true TRL or LRM.

Four-receiver analyzers employ a second reference receiver, so forward and reverse sweeps each have their own reference receiver. This eliminates any nonsymmetrical effects of the transfer switch. Four-receiver analyzers are more expensive, but provide better accuracy for noncoaxial measurements. With a four-receiver architecture, true TRL calibrations can be performed.

Why Are Four Receivers Better Than Three?

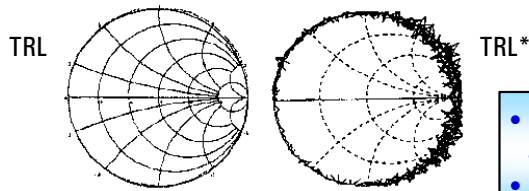

- 8720ES Option 400 adds fourth sampler, allowing full TRL calibration
- PNA Series has four receivers standard

- **TRL***
 - assumes the **source and load match** of a test port are **equal** (port symmetry between forward and reverse measurements)
 - this is only a fair assumption for three-receiver network analyzers
- **TRL**
 - four receivers are necessary to make the required measurements
 - TRL and TRL* use identical calibration standards
- **In noncoaxial applications**, TRL achieves **better source and load match correction** than TRL*
- **What about coaxial applications?**
 - **SOLT is usually the preferred calibration method**
 - coaxial TRL can be more accurate than SOLT, but not commonly used

Network Analyzer Basics



www.agilent.com/find/backtobasics

Slide 131

Just what is the difference between TRL and TRL*? TRL* assumes the source and load match of a test port are equal (i.e., there is port-impedance symmetry between forward and reverse measurements). This is only a fair assumption for a three-receiver network analyzer. TRL* requires ten measurements to quantify eight unknowns. True TRL calibration requires four receivers (two reference receivers plus one each for reflection and transmission) and fourteen measurements to quantify ten unknowns. TRL and TRL* use identical calibration standards. The isolation portion of a TRL calibration is the same as for SOLT.

In noncoaxial applications, TRL achieves better source match and load match correction than TRL*, resulting in less measurement error. For coaxial applications, SOLT calibration is almost always the preferred method. Agilent can provide coaxial calibration kits all the way up to 110 GHz, with a variety of connector types. While not commonly done, coaxial TRL calibration can be more accurate than SOLT calibration, but only if very-high quality coaxial transmission lines (such as beadless airlines) are used.

Option 400 for the 8720 series adds a fourth sampler, allowing these analyzers to do a full TRL calibration. The PNA Series feature four measurement receivers in the standard product.

Challenge Quiz

1. Can filters cause distortion in communications systems?

- A. Yes, due to impairment of phase and magnitude response
- B. Yes, due to nonlinear components such as ferrite inductors
- C. No, only active devices can cause distortion
- D. No, filters only cause linear phase shifts
- E. Both A and B above

2. Which statement about transmission lines is false?

- A. Useful for efficient transmission of RF power
- B. Requires termination in characteristic impedance for low VSWR
- C. Envelope voltage of RF signal is independent of position along line
- D. Used when wavelength of signal is small compared to length of line
- E. Can be realized in a variety of forms such as coaxial, waveguide, microstrip

3. Which statement about narrowband detection is false?

- A. Is generally the cheapest way to detect microwave signals
- B. Provides much greater dynamic range than diode detection
- C. Uses variable-bandwidth IF filters to set analyzer noise floor
- D. Provides rejection of harmonic and spurious signals
- E. Uses mixers or samplers as downconverters

Challenge Quiz (continued)

4. Maximum dynamic range with narrowband detection is defined as:

- A. Maximum receiver input power minus the stopband of the device under test
- B. Maximum receiver input power minus the receiver's noise floor
- C. Detector 1-dB-compression point minus the harmonic level of the source
- D. Receiver damage level plus the maximum source output power
- E. Maximum source output power minus the receiver's noise floor

5. With a T/R analyzer, the following error terms can be corrected:

- A. Source match, load match, transmission tracking
- B. Load match, reflection tracking, transmission tracking
- C. Source match, reflection tracking, transmission tracking
- D. Directivity, source match, load match
- E. Directivity, reflection tracking, load match

6. Calibration(s) can remove which of the following types of measurement error?

- A. Systematic and drift
- B. Systematic and random
- C. Random and drift
- D. Repeatability and systematic
- E. Repeatability and drift

Challenge Quiz (continued)

7. Which statement about TRL calibration is false?

- A. Is a type of two-port error correction
- B. Uses easily fabricated and characterized standards
- C. Most commonly used in noncoaxial environments
- D. Is not available on the 8720ES family of microwave network analyzers
- E. Has a special version for three-sampler network analyzers

8. For which component is it hardest to get accurate transmission and reflection measurements when using a T/R network analyzer?

- A. Amplifiers because output power causes receiver compression
- B. Cables because load match cannot be corrected
- C. Filter stopbands because of lack of dynamic range
- D. Mixers because of lack of broadband detectors
- E. Attenuators because source match cannot be corrected

9. Power sweeps are good for which measurements?

- A. Gain compression
- B. AM to PM conversion
- C. Saturated output power
- D. Power linearity
- E. All of the above

Network Analyzer Basics



Agilent Technologies

www.agilent.com/find/backtobasics

Answers to Challenge Quiz

1. E
2. C
3. A
4. B
5. C
6. A
7. D
8. B
9. E

Slide 135

The correct answers to the challenge quiz are:

1. E
2. C
3. A
4. B
5. C
6. A
7. D
8. B
9. E