

Agilent AN 1286-1

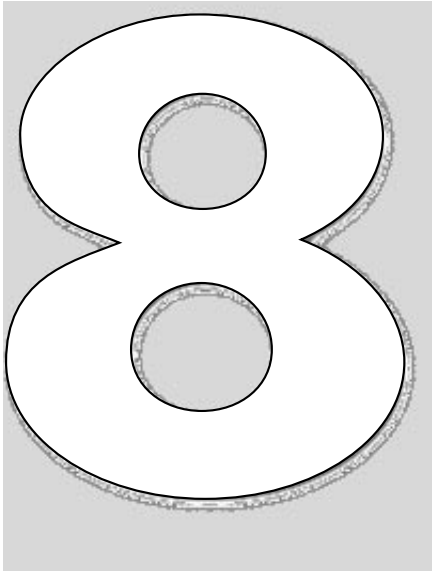

Hints  
for making  
**Better**  
Spectrum  
Analyzer  
Measurements

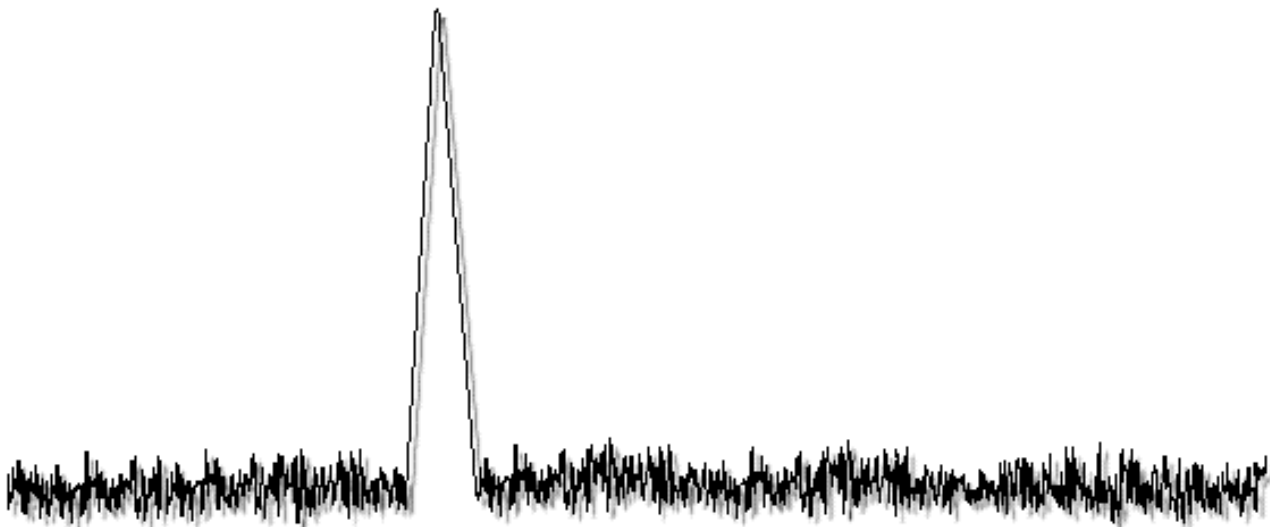

**Agilent Technologies**  
Innovating the HP Way

# The Heterodyne Spectrum Analyzer

The spectrum analyzer, like an oscilloscope, is a basic tool used for observing signals. Where the oscilloscope provides a window into the time domain, the spectrum analyzer provides a window into the frequency domain, as depicted in Figure 1.

Figure 2 depicts a simplified block diagram of a swept-tuned spectrum analyzer. In the analyzer, a signal at the input first travels through the attenuator and the low-pass input filter. The attenuator then limits the amplitude of the signal, while the filter eliminates undesirable frequencies.

Past the input filter, the signal gets mixed with another signal generated by a voltage controlled oscillator (VCO).

The frequency of the VCO is controlled by a repeating ramp generator, whose voltage also drives the horizontal axis of the display. As the frequency of the VCO changes, the mixed input signal sweeps through the resolution bandwidth filter (IF filter), which is fixed in frequency. A detector then measures the power level of the signal passing through the IF filter, producing a DC voltage that drives the vertical portion

of the display. As the VCO sweeps through its frequency range, a trace is drawn across the screen. This trace shows the spectral content of the input signal within a selected range of frequencies.

There are three essential steps in any spectrum analyzer measurement:

- Preparing the input signal for measurement
- Preparing the spectrum analyzer for measurement
- Interpreting and interrogating the results

This guide provides useful insights and tips for more effective use of the heterodyne spectrum analyzer in each of these areas.

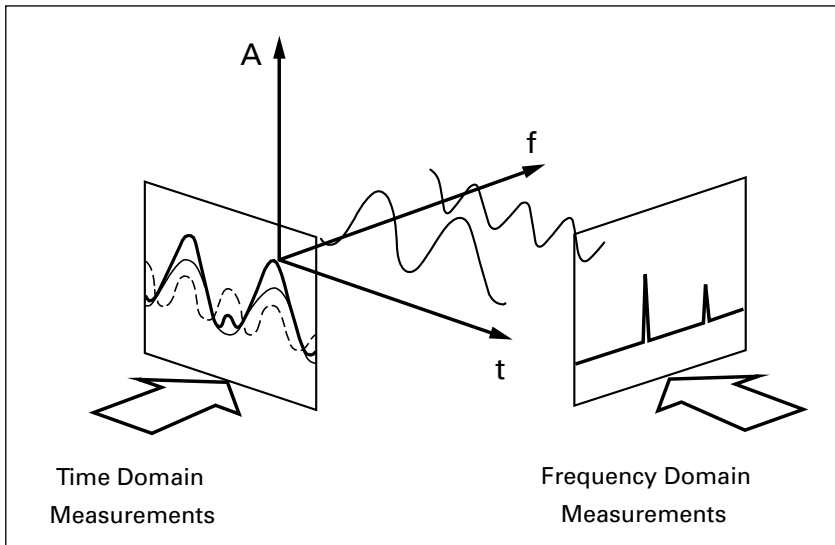

Figure 1. Measurement domain.

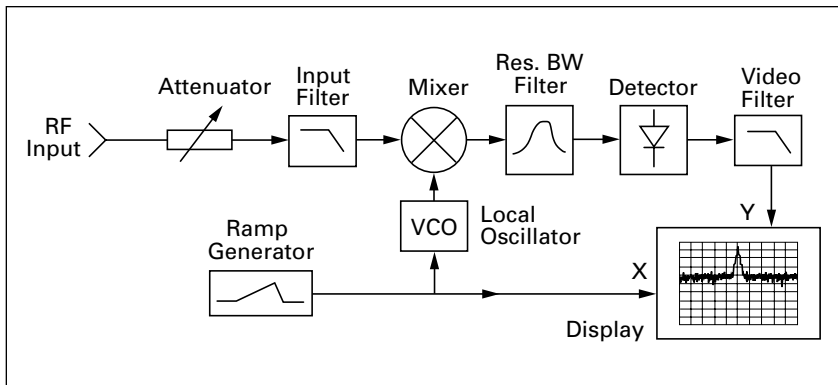

Figure 2. Spectrum analyzer block diagram.

# Improving Amplitude Measurements with Amplitude Correction (Ampcor)

# HINT 1

When making accurate amplitude measurements with a spectrum analyzer, it is crucial that any effects that degrade or alter the signal of interest in between the device under test (DUT) and the analyzer be canceled out of the measurement. One method of accomplishing this is to use the analyzer's built-in amplitude correction (Ampcor) function in conjunction with a signal source and a power meter. Ampcor takes a list of frequency and amplitude pairs, linearly connects the points to make a correction "waveform," then offsets the input signal according to these corrections.

Figure 2 depicts the frequency response of a signal delivery network that not only attenuates the DUT's signal, but also injects a noise spike. To cancel out these unwanted effects, first measure (with the source and power meter) the attenuation/gain of the signal delivery network at the troublesome frequency points in the measurement range. For example, at 600 MHz, send a 0 dBm signal through the network to the power meter. The reading on the power meter indicates the attenuation or gain associated with that frequency point. Doing this at different points throughout the frequency range will yield the table of frequency and amplitude points to be fed into the Ampcor table.

Figure 3 shows an Ampcor table with the relative amplitude correction waveform in the background. Notice that the peaks in the amplitude correction waveform coincide with the valleys of the signal delivery network.

Now, with Ampcor turned on, the unwanted attenuation and gain of the signal delivery network have been eliminated from the measurement.

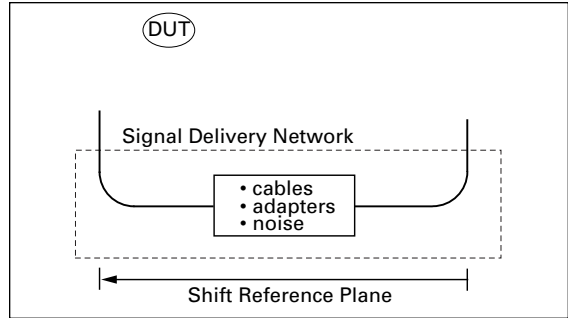

Figure 1. Test setup.

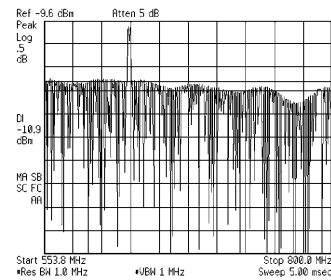

Figure 2. Original signal.

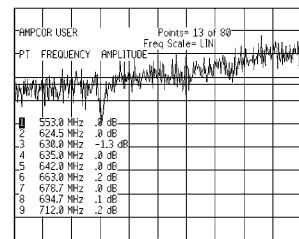

Figure 3. Correction factors.

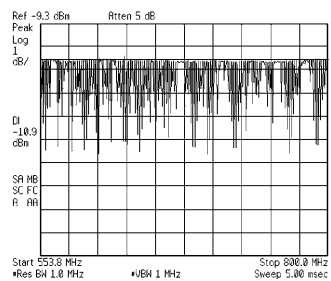

Figure 4. Corrected signal.

# Stimulus-Response Measurements: Filter Return Loss



The spectrum analyzer, when combined with a tracking generator, forms a stimulus-response measurement system. With the tracking generator as the swept source and the spectrum analyzer as the receiver, the operation is the same as a network analyzer.

To measure the return loss of a filter, you need a spectrum analyzer equipped with a tracking generator, a bridge, (directional coupler) and a short-circuit as shown in Figure 1.

First, with the filter DUT in place, set the analyzer to the desired frequency span. Connect the DUT input to the output port of the bridge and terminate the unconnected port of the DUT with a matched load. Connect the tracking generator output to the input port of the bridge, and the spectrum analyzer input to the coupled port of the bridge.

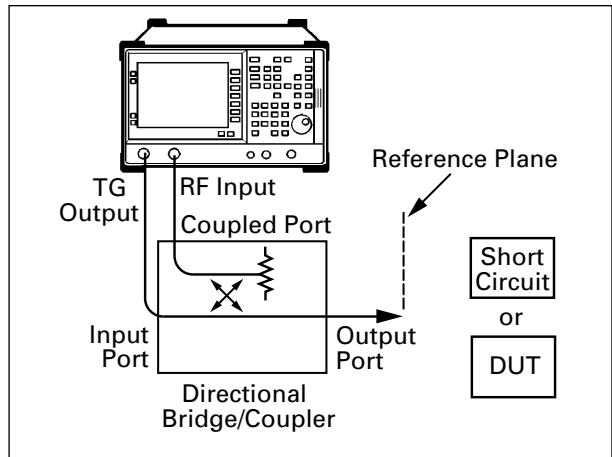

Figure 1. Stimulus response setup.

Once the measurement is set up, turn on the tracking generator output and adjust its amplitude. Now replace the DUT with a short circuit. A short circuit reflects all incident power and has a reflection coefficient of 1 (0 dB return loss).

Next, normalize the display with the spectrum analyzer's normalize function (most analyzers have this). The normalize function eliminates the frequency response error of the test system, providing a convenient 0 dB return loss reference at the top of the display.

Finally, reconnect the filter in place of the short circuit without changing any of the settings on the spectrum analyzer. Use the marker to read the return loss at any frequency point.

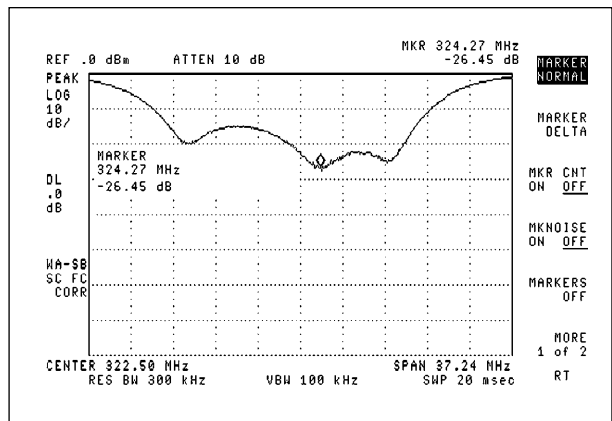

Figure 2. Return loss measurement.

# Measuring Low-Level Signals

# HINT 3

The spectrum analyzer's ability to measure low-level signals is limited by the noise generated inside the spectrum analyzer. This sensitivity to low-level signals is affected by the measurement setup.

Figure 1, for example, depicts a 50 MHz signal that appears to be shrouded by the analyzer's noise floor.

The spectrum analyzer *input attenuator* and *resolution bandwidth* settings are the key factors that determine how small of a signal the spectrum analyzer can measure.

The input attenuator, when activated, reduces the level of the signal at the input of the mixer. An amplifier at the mixer's output then re-amplifies the attenuated signal to keep the signal peak at the same point on the analyzer's display. In addition to amplifying the input signal, the noise present in the analyzer is amplified as well. This has the effect of raising the displayed noise level of the analyzer.

The resolution bandwidth filter affects how closely a small signal can be seen in the presence of a large one. By increasing the width of this filter, more noise energy is allowed to hit the envelope detector of the analyzer. This also has the effect of raising the displayed noise level of the analyzer.

For maximum sensitivity, both the input attenuator and resolution bandwidth settings must be minimized. Figure 2 shows the signal of Figure 1 after the attenuator and resolution bandwidth have been minimized.

If, after adjusting the attenuation and resolution bandwidth, a signal is still near the noise, stability of the displayed trace can be improved by *video averaging* or *video filtering* the display. Figure 3 shows the final video averaged signal.

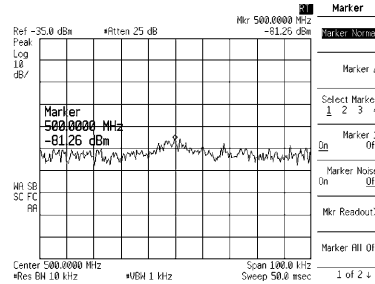

Figure 1. Noise obscuring signal.

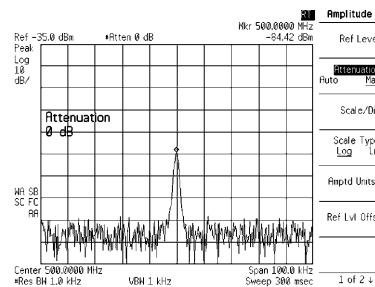

Figure 2. After minimizing attenuator and resolution bandwidth.

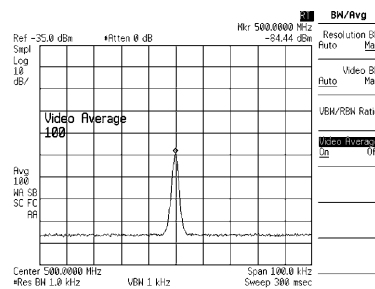

Figure 3. Signal after video averaging.

# Identifying Internal Distortion Products

# HINT 4

High-level input signals may cause internal spectrum analyzer distortion products that could mask the real distortion measured on the input signal. Using dual traces and the analyzer's RF attenuator, you can determine which signals, if any, are internally generated distortion products.

To identify these products, tune to the second harmonic of the input signal and set the input attenuator to 0 dBm. Next, save the screen data in Trace B, select Trace A as the active trace, and activate Marker  $\Delta$ . The spectrum analyzer now shows the stored data in Trace B and the measured data in Trace A, while Marker  $\Delta$  shows the amplitude and frequency difference between the two traces. Finally, increase the RF attenuation by 10 dB and compare the response in Trace A to the response in Trace B.

If the responses in Trace A and Trace B differ, as in Figure 1, then the analyzer's mixer is generating internal distortion products due to the high level of the input signal. In this case, attenuation is required.

In Figure 2, since there is no change in the signal level, the distortion is not caused internally. The distortion that is displayed is present on the input signal.

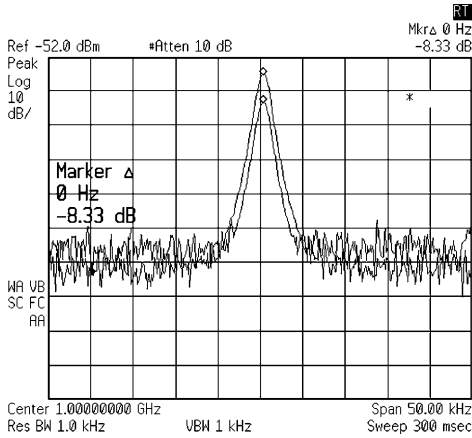

Figure 1. Internally generated distortion products.

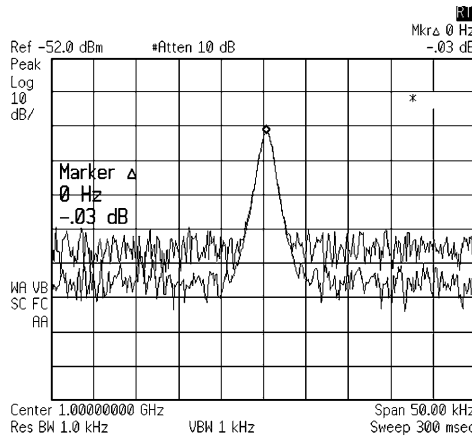

Figure 2. Externally generated distortion products.

# Selecting the Best Display Detection Mode

HINT

5

Modern spectrum analyzers utilize digital technology for data acquisition and manipulation. In these analyzers, the analog signal at the input of the analyzer is segmented into “bins,” which are digitally sampled for further data processing and display, as shown in Figure 1. The question that naturally arises is: What point in the bin do we use for our data point? Spectrum analyzers generally have two or three detector modes that dramatically affect how the input signal is interpreted and displayed.

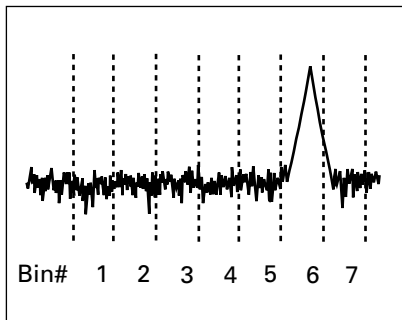

Figure 1. Sampling bins.

Peak detection mode detects the highest power level in each bin. Peak detection is good for analyzing sinusoids, but tends to over-respond to noise when no sinusoids are present.

Sample detection mode displays the last point in each bin, regardless of power. Sample detection is good for noise measurements, and accurately indicates the true randomness of noise. Sample detection, however, is inaccurate for measuring continuous wave (CW) signals with narrow resolution bandwidths, and will miss signals that do not fall on the same point in each bin.

Negative Peak detection mode displays the lowest power level in each bin. This mode is good for AM/FM demodulation and distinguishing between random and impulse noise. Negative peak detection does not give the analyzer better sensitivity, although the noise floor may appear to drop.

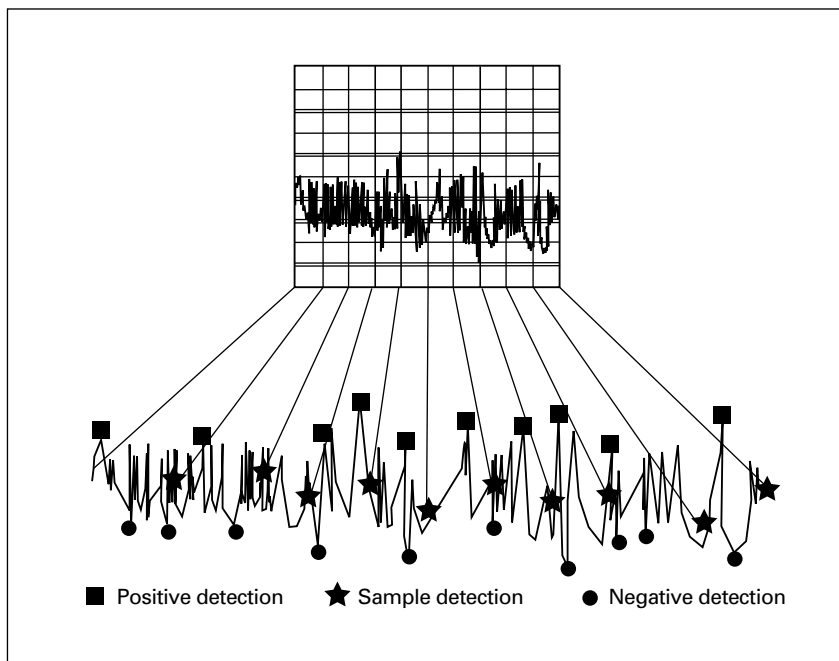
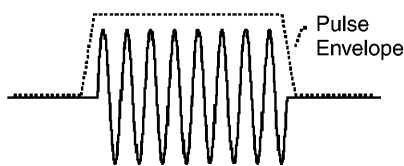

Figure 2. Detection modes.

Higher performance spectrum analyzers also have a detection mode called *rosenfell*. This sampling mode dynamically classifies the data point as either noise or a signal, providing a better visual display of random noise than peak detection while avoiding the missed-signal problem of sample detection.

# Measuring Burst Signals: Time Gated Spectrum Analysis

# HINT 6



Analyzing burst signals (pulses) with a spectrum analyzer is very challenging because in addition to displaying the information carried by the pulse, the analyzer displays the frequency content of the shape of the pulse (pulse envelope) as well. The sharp rise and fall times of the pulse envelope can create unwanted frequency components that add to the frequency content of the original signal. These unwanted frequency components may be so bad that they completely obscure the signal of interest.

Figure 1, for example, depicts the frequency content of a pulse carrying a simple AM signal. In this case, the AM sidebands are almost completely shrouded by spectral “noise” of the pulse envelope.

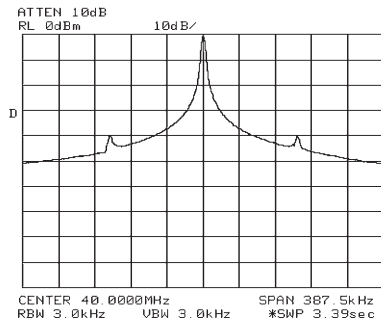

Figure 1. Signal without time gating.

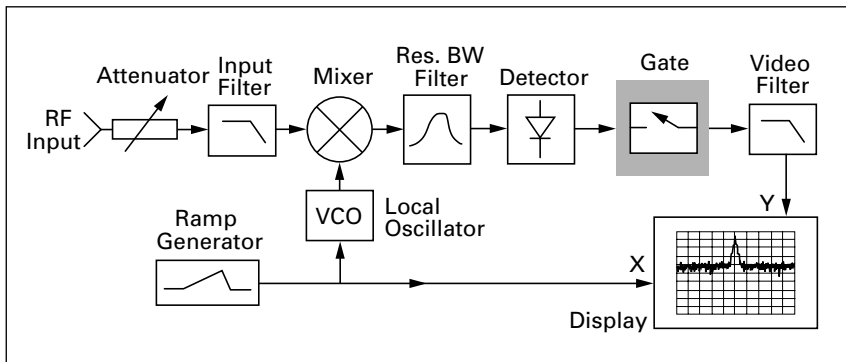

Figure 2. Spectrum analyzer block diagram with time gating.

Time gated spectral analysis permits analysis of the contents of the pulse without the effect of the envelope of the pulse itself. As the name implies, time gating is achieved by placing a gate (switch) in the video path of the spectrum analyzer as shown in Figure 2.

In a time gated measurement, the analyzer senses when the burst starts, then triggers a delay so the resolution filter has time to react to the sharp rise time of the pulse, and finally stops the analysis before the burst ends. By doing this, only the information carried by the pulse is analyzed, as is shown in Figure 3. It is now clear that our pulse contained a 40 MHz carrier modulated by a 100 kHz sinusoidal signal.

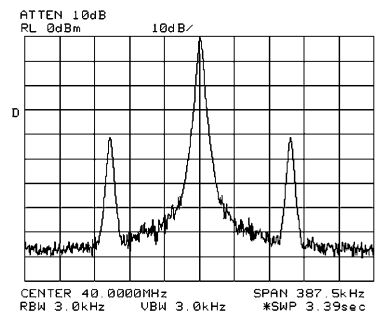

Figure 3. Signal with time gating.



# AM Measurements Using Zero Span and FFT

# HINT 7

In addition to the swept-tuned frequency mode, spectrum analyzers can also be used in the fixed-tuned mode (zero span) to provide time domain measurement capability much like that of an oscilloscope.

One of the most powerful uses of zero span is in making quick measurements of amplitude modulation.

To make AM measurements using zero span, the center frequency of the analyzer is set to the AM carrier frequency while the resolution bandwidth of the analyzer is set so that it is wide enough to pass the side-bands unattenuated, as shown in Figure 1. Then the analyzer span is set to 0 Hz. This causes the analyzer to stop sweeping and act as a fixed-tuned receiver, displaying signal amplitude versus time as opposed to frequency versus time.

With the analyzer set to linear display mode, the display shows the sinusoidal variation in carrier amplitude due to the amplitude modulation. Figure 2 reveals that our carrier was modulated by a 4 kHz sinusoidal signal.

The maximum modulation frequency that may be resolved using zero span is determined by the analyzer's maximum resolution bandwidth and its minimum sweep time.

While zero span gives us the frequency of the modulating signal, it tells us nothing about the quality of this signal. If your analyzer has a built-in fast fourier transform (FFT) function, perform an FFT on the zero span signal of Figure 2. Your analyzer will now show the frequency content of the modulating signal. In Figure 3, we see that the carrier was indeed modulated by a high quality 4 kHz sinusoidal signal.

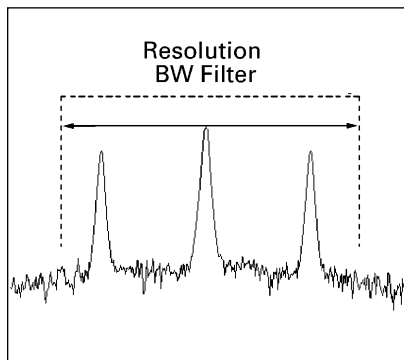

Figure 1. Resolution bandwidth setting.

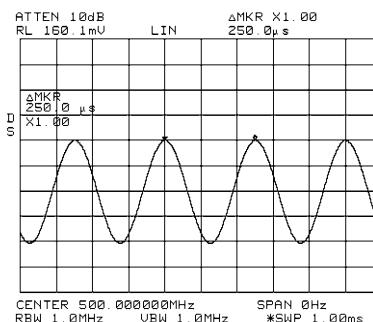

Figure 2. Zero span.

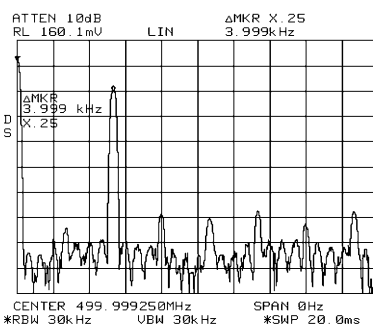

Figure 3. FFT of zero span signal.

# Eliminating the Grease Pencil: Limit Lines



In many situations, it is necessary to quickly test a signal to see whether or not it falls within a set of frequency, amplitude, or time boundaries. For example, a radio transmitter manufacturer would want to make sure that the center frequency of a signal carrier falls within a certain amplitude and frequency “mask” and might tune a variable capacitor or resistor until it does. During this tuning, the manufacturer will require constant feedback from the spectrum analyzer indicating whether or not the carrier fits within the mask.

In some cases, grease pencils are used to sketch these “limit” lines right on the display of the analyzer. Modern spectrum analyzers provide electronic limit line capability, providing more precise, and needless to say, much cleaner ways of making these measurements.

Limit lines compare trace data to a set of amplitude and frequency (or time) parameters while the spectrum analyzer is sweeping the measurement range. Like Ampcor tables, limit lines are entered into the analyzer’s memory as sets of linearly connected frequency and amplitude points. When the signal of interest falls within the limit line boundaries, a display indicating LIMIT PASS (on Agilent analyzers) appears. If the signal should fall out of the limit line boundaries, LIMIT FAIL appears on the display. Figures 2 and 3 show simple upper limit line tests.

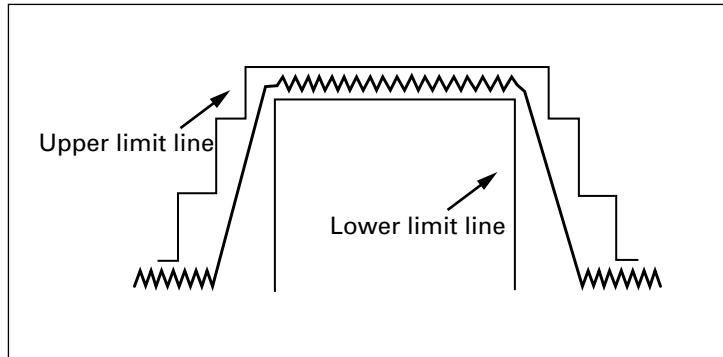

Figure 1. Limit lines.

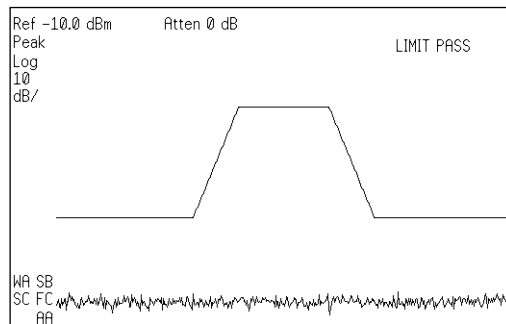

Figure 2. Mask not violated.

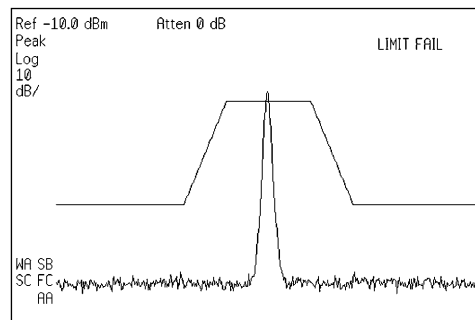

Figure 3. Mask violation.

# Agilent Portable Spectrum Analyzers

## Agilent 8560 E-Series

Providing high performance, capability, and quality for the most demanding measurements, these spectrum analyzers have the performance and features you require on the R&D bench.

With the reliability and speed you depend upon in production and the ease-of-use, portability, and MIL-ruggedness you expect in the field, these analyzers will meet your high performance needs.

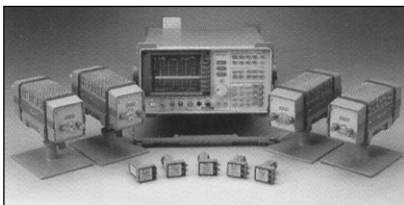
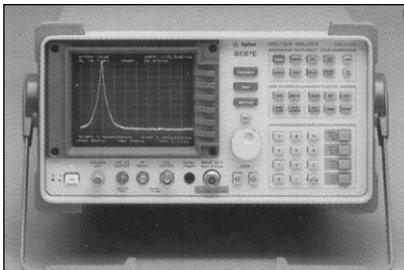
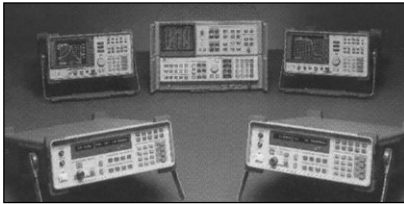

**“One of them is ideal for what you want to do.”**

## Agilent 8590 E-Series

These application-specific spectrum analyzers adapt to your evolving spectrum analysis needs.

Optional hardware configurations include time gating, EMI pre-compliance, scalar measurements, and digital demodulation for all major cellular and cordless formats.

Downloadable measurement personalities add powerful measurement routines.

(Updated measurement personalities now conform to IS-136 NADC, J-STD-008 CDMA, and I-ETS 300 131 CT2 communications standards.)

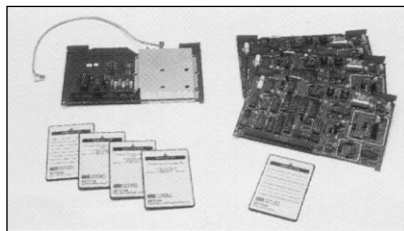
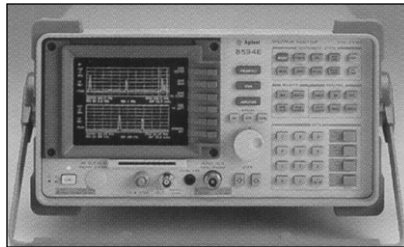

## Agilent ESA-L1500A (Order number E4411A)

Agilent sets a new performance standard for low-cost spectrum analyzers.

The rain-resistant front panel and rugged packaging are designed for making measurements in diverse weather conditions.

The automatic background calibration and overload protection provide increased measurement confidence and reliability.

An enhanced user interface with a large, high-resolution, active matrix LCD display makes measurements easy to make and easy to see.



**Agilent Technologies' Test and Measurement Support, Services, and Assistance**

Agilent Technologies aims to maximize the value you receive, while minimizing your risk and problems. We strive to ensure that you get the test and measurement capabilities you paid for and obtain the support you need. Our extensive support resources and services can help you choose the right Agilent products for your applications and apply them successfully. Every instrument and system we sell has a global warranty. Support is available for at least five years beyond the production life of the product. Two concepts underlie Agilent's overall support policy: "Our Promise" and "Your Advantage."

**Our Promise**

"Our Promise" means your Agilent test and measurement equipment will meet its advertised performance and functionality. When you are choosing new equipment, we will help you with product information, including realistic performance specifications and practical recommendations from experienced test engineers. When

you use Agilent equipment, we can verify that it works properly, help with product operation, and provide basic measurement assistance for the use of specified capabilities, at no extra cost upon request. Many self-help tools are available.

**Your Advantage**

"Your Advantage" means that Agilent offers a wide range of additional expert test and measurement services, which you can purchase according to your unique technical and business needs. Solve problems efficiently and gain a competitive edge by contracting with us for calibration, extra-cost upgrades, out-of-warranty repairs, and on-site education and training, as well as design, system integration, project management, and other professional services. Experienced Agilent engineers and technicians worldwide can help you maximize your productivity, optimize the return on investment of your Agilent instruments and systems, and obtain dependable measurement accuracy for the life of those products.

By internet, phone, or fax, get assistance with all your test and measurement needs.

**Online Assistance**

[www.agilent.com/find/assist](http://www.agilent.com/find/assist)

**Phone or Fax**

United States:  
(tel) 1 800 452 4844

Canada:  
(tel) 1 877 894 4414  
(fax) (905) 206 4120

Europe:  
(tel) (31 20) 547 2323  
(fax) (31 20) 547 2390

Japan:  
(tel) (81) 426 56 7832  
(fax) (81) 426 56 7840

Latin America:  
(tel) (305) 269 7500  
(fax) (305) 269 7599

Australia:  
(tel) 1 800 629 485  
(fax) (61 3) 9210 5947

New Zealand:  
(tel) 0 800 738 378  
(fax) (64 4) 495 8950

Asia Pacific:  
(tel) (852) 3197 7777  
(fax) (852) 2506 9284

Product specifications and descriptions in this document subject to change without notice.

Copyright © 1998, 2000 Agilent Technologies  
Printed in U.S.A. 9/00  
5965-7009E



**Agilent Technologies**

Innovating the HP Way